

HAND CRIMPER

PORTABLE MANUALLY OPERATED SWAGING MACHINE

FOR SERVICING IN THE FIELD
MAX. FITTING DIAMETER 1" - 4 SPIRAL HOSE

THE LIGHTWEIGHT CHAMPION

VISUAL



The powerful portable swaging machine is ideal for use in the field, workshops and where electrical power is not available.

The machine is delivered with five standard sets of dies. The pump lever is detachable. The swaging is controlled optically with a pressure gauge.

Technical Specifications		Dimensions	
Max. fitting size	1"	Height	340 mm
Swaging Force	1100 kN	Width	190 mm
Max. Pressure	300 bar \ 4500 PSI	Depth	285 mm
		Weight	32 kg
Dies Included			
1/4"			
3/8"			
1/2"			
3/4"			
1"			

BRASS FITTINGS & NYLON TUBING

N711

NYLON TUBING - IMPERIAL

Part No.	Price	O.D.	Visual
N711-02		1/8	
N711-03		3/16	
N711-04		1/4	
N711-05		5/16	
N711-06		3/8	
N711-08		1/2	

N1112

NYLON TUBING - METRIC

Part No.	Price	O.D.	Visual
N1112-04M		4 mm	
N1112-06M		6 mm	
N1112-08M		8 mm	
N1112-10M		10 mm	
N1112-11M		11 mm	
N1112-12M		12 mm	
N1112-15M		15 mm	
N1112-16M		16 mm	

7009

PVC CLEAR RE-INFORCED

Part No.	Price	I.D.	Visual
7009-03		3/8	
7009-04		1/4	
7009-05		5/16	
7009-06		3/8	
7009-08		1/2	
7009-10		5/8	
7009-12		3/4	
7009-16		1	
7009-20		1 1/4	
7009-24		1 1/2	
7009-32		2	

PU

BLUE POLYESTER TUBING

Part No.	Price	I.D.	Visual
PU-08M		8mm	



BRASS FITTINGS

122

HEX NIPPLE

124

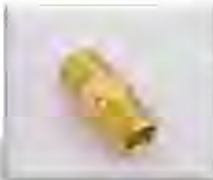
PIPE 45°

Part No.	Price	Size	Visual	Part No.	Price	Size	Visual
122-0202		1/8 - 1/8		124-02		1/8	
122-0402		1/4 - 1/8		124-04		1/4	
122-0404		1/4 - 1/4		124-06		3/8	
122-0602		3/8 - 1/8		124-08		1/2	
122-0604		3/8 - 1/4					
122-0606		3/8 - 3/8					
122-0804		1/2 - 1/4					
122-0806		1/2 - 3/8					
122-0808		1/2 - 1/2					
122-1212		3/4 - 3/4					

127

PIPE MALE RUN TEE

AF

HOSE MENDER



Part No.	Price	Size	Visual	Part No.	Price	Size	Visual
127-02		1/8		AF-19		3/16	
127-04		1/4		AF-20		1/4	
127-06		3/8		AF-21		5/16	
127-08		1/2		AF-22		3/8	
				AF-23		1/2	

AF

NPT MALE HOSE CONNECTOR

828

BRASS BARB TEE

Part No.	Price	Thread Hose	Visual	Part No.	Price	Size	Visual
AF-203		1/8 - 3/16		828-040404		6mm	
AF-204		1/8 - 1/4		828-050505		8mm	
AF-205		1/8 - 5/16		828-060606		10mm	
AF-206		1/8 - 3/8		828-080808		12mm	
AF-402		1/4 - 1/8					
AF-403		1/4 - 3/16					
AF-404		1/4 - 1/4					
AF-405		1/4 - 5/16					
AF-406		1/4 - 3/8					
AF-408		1/4 - 1/2					
AF-604		3/8 - 1/4					
AF-605		3/8 - 5/16					
AF-606		3/8 - 3/8					
AF-608		3/8 - 1/2					
AF-610		3/8 - 5/8					
AF-804		1/2 - 1/4					
AF-805		1/2 - 5/16					
AF-806		1/2 - 3/8					
AF-808		1/2 - 1/2					
AF-810		1/2 - 5/8					
AF-812		1/2 - 3/4					
AF-1208		3/4 - 1/2					
AF-1212		3/4 - 3/4					

BRASS FITTINGS

109

HEX PLUG

110

PIPE REDUCING BUSH - NPT

Part No.	Price	Size	Visual	Part No.	Price	Size	Visual
109-02		1/8		110-0402		1/4 - 1/8	
109-04		1/4		110-0602		3/8 - 1/8	
109-06		3/8		110-0604		3/8 - 1/4	
109-08		1/2		110-0802		1/2 - 1/8	
109-12		3/4		110-0804		1/2 - 1/4	
				110-0806		1/8 - 3/8	
			110-1202		3/4 - 1/8		
			110-1204		3/4 - 1/4		
			110-1206		3/4 - 3/8		
			110-1208		3/4 - 1/2		

112

FEMALE TEE

114

FEMALE ELBOW

Part No.	Price	Size	Visual	Part No.	Price	Size	Visual
112-02		1/8		114-02		1/8	
112-04		1/4		114-04		1/4	
112-06		3/8		114-06		3/8	
112-08		1/2		114-08		1/2	
112-12		3/4					

115

MALE BRANCH 'T'

116

FEMALE CROSS

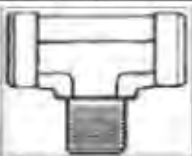
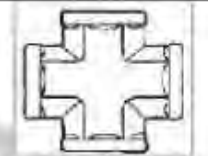
Part No.	Price	Size	Visual	Part No.	Price	Size	Visual
115-02		1/8		116-02		1/8 - 1/8	
115-04		1/4		116-04		3/16 - 1/8	
115-06		3/8		116-06		3/16 - 1/4	

117

MALE\FEMALE ELBOW

120

MALE\FEMALE ADAPTOR

Part No.	Price	Size	Visual	Part No.	Price	Size	Visual
117-0202		1/8 - 1/8		120-0202		1/8 - 1/8	
117-0402		1/4 - 1/8		120-0204		1/8 - 1/4	
117-0404		1/4 - 1/4		120-0402		1/4 - 1/8	
117-0606		3/8 - 3/8		120-0404		1/4 - 1/4	
117-0808		1/2 - 1/2		120-0604		3/8 - 1/4	
117-1212		3/4 - 3/4		120-0606		3/8 - 3/8	
				120-0804		1/2 - 1/4	
			120-0806		1/2 - 3/8		
			120-0808		1/2 - 1/2		

BRASS FITTINGS

68

COMPRESSION NUT

68M

METRIC BRASS MALE

Part No.	Price	Size	Visual	Part No.	Price	Size	Visual
68-0202		1/8 - 1/8		68-04M-02		4mm - 1/8	
68-0302		3/16 - 1/8		68-04M-04		4mm - 1/4	
68-0304		3/16 - 1/4		68-06M-02		6mm - 1/8	
68-0402		1/4 - 1/8		68-06M-04		6mm - 1/4	
68-0404		1/4 - 1/4		68-08M-02		8mm - 1/8	
68-0406		1/4 - 3/8		68-08M-04		8mm - 1/4	
68-0408		1/4 - 1/2		68-08M-06		8mm - 3/8	
68-0502		5/16 - 1/8		68-10M-04		10mm - 1/4	
68-0504		5/16 - 1/4		68-10M-06		10mm - 3/8	
68-0506		5/16 - 3/8		68-10M-08		10mm - 1/2	
68-0602		3/8 - 1/8		68-12M-06		12mm - 3/8	
68-0604		3/8 - 1/4		68-12M-08		12mm - 1/2	
68-0606		3/8 - 3/8					
68-0608		3/8 - 1/2					
68-0804		1/2 - 1/4					
68-0806		1/2 - 3/8					
68-0808		1/2 - 1/2					
68-0812		1/2 - 3/4					
68-1006		5/8 - 3/8					
68-1008		5/8 - 1/2					
68-1208		3/4 - 1/2					
68-1212		3/4 - 3/4					

69

MALE ELBOW

103

PIPE SOCKET

Part No.	Price	Size	Visual	Part No.	Price	Size	Visual
69-0202		1/8 - 1/8		103-02		1/8 - 1/8	
69-0302		3/16 - 1/8		103-04		1/4 - 1/4	
69-0304		3/16 - 1/4		103-06		3/8 - 3/8	
69-0402		1/4 - 1/8		103-08		1/2 - 1/2	
69-0404		1/4 - 1/4		103-12		3/4 3/4	
69-0406		1/4 - 3/8					
69-0502		5/16 - 1/8					
69-0504		5/16 - 1/4					
69-0506		5/16 - 3/8					
69-0602		3/8 - 1/8					
69-0604		3/8 - 1/4					
69-0606		3/8 - 3/8					
69-0608		3/8 - 1/2					
69-0804		1/2 - 1/4					
69-0806		1/2 - 3/8					
69-0808		1/2 - 1/2					
69-1006		5/8 - 3/8					
69-1008		5/8 - 1/2					
69-1208		3/4 - 1/2					
69-1212		3/4 - 3/4					

64

COMPRESSION TEE

64M

METRIC COMPRESSION TEE

Part No.	Price	Size	Visual	Part No.	Price	Size	Visual
64-02		1/8		64-04M		4mm	
64-03		3/16		64-06M		6mm	
64-04		1/4		64-08M		8mm	
64-05		5/16		64-10M		10mm	
64-06		3/8		64-12M		12mm	
64-08		1/2					
64-10		5/8					

65

UNION ELBOW

65M

METRIC COMPRESSION ELBOW

Part No.	Price	Size	Visual	Part No.	Price	Size	Visual
65-02		1/8		65-04M		1/8	
65-03		3/16		65-05M		3/16	
65-04		1/4		65-06M		1/4	
65-05		5/16		65-08M		5/16	
65-06		3/8		65-10M		3/8	
65-08		1/2		65-12M		1/2	
65-10		5/8					
65-12		3/4					

66

FEMALE CONNECTOR

Part No.	Price	Size	Visual
66-0202		1/8 - 1/8	
66-0302		3/16 - 1/8	
66-0402		1/4 - 1/8	
66-0404		1/4 - 1/4	
66-0406		1/4 - 3/8	
66-0502		5/16 - 1/8	
66-0504		5/16 - 1/4	
66-0602		3/8 - 1/8	
66-0604		3/8 - 1/4	
66-0606		3/8 - 3/8	
66-0608		3/8 - 1/2	
66-0804		1/2 - 1/4	
66-0806		1/2 - 3/8	
66-0808		1/2 - 1/2	
66-1008		5/8 - 1/2	
66-1208		3/4 - 1/2	

BRASS - COMPRESSION FITTINGS

48

SAE 45 FLARE MALE CONNECTOR

49

SAE 45 FLARE MALE ELBOW



Part No.	Price	Size	Visual	Part No.	Price	Size	Visual
48-0404		1/4 - 1/4		49-0404		1/4 - 1/4	
48-0604		3/8 - 1/4		49-0604		3/8 - 1/4	
48-0606		3/8 - 3/8		49-0806		1/2 - 3/8	
48-0608		3/8 - 1/2		49-1006		5/8 - 3/8	
48-0808		1/2 - 1/2					

60

COMPRESSION SLEEVE

61

COMPRESSION NUT

Part No.	Price	Size	Visual	Part No.	Price	Size	Visual
60-02		1/8		61-02		1/8	
60-03		3/16		61-03		3/16	
60-04		1/4		61-04		1/4	
60-05		5/16		61-05		5/16	
60-06		3/8		61-06		3/8	
60-07		7/16		61-07		7/16	
60-08		1/2		61-08		1/2	
60-10		5/8		61-10		5/8	
60-12		3/4		61-12		3/4	

62

COMPRESSION UNION

62M

METRIC BRASS UNION

Part No.	Price	Size	Visual	Part No.	Price	Size	Visual
62-02		1/8		62-04M		4mm	
62-03		3/16		62-06M		6mm	
62-04		1/4		62-08M		8mm	
62-05		5/16		62-10M		10mm	
62-06		3/8		62-12M		12mm	
62-07		7/16					
62-08		1/2					
62-10		5/8					
62-12		3/4					

63

COMPRESSION NUT

Part No.	Price	Size	Visual
63-03		3/16	
63-04		1/4	
63-05		5/16	
63-06		3/8	
63-08		1/2	

Brass Fittings Index

Brass Fittings & Nylon Tubing

SAE 45 Flare Male Connector	48	Page 1
SAE 45 Flare Male Elbow	49	Page 1
Ferrule	60	Page 1
Compression Nut	61	Page 1
Compression Union	62	Page 1
Metric Brass Union	62M	Page 1
Tube Inserts	63	Page 1
Compression Tee	64	Page 2
Metric Compression Tee	64M	Page 2
Compression Elbow	65	Page 2
Metric Compression Elbow	65M	Page 2
Compression Female Connector	66	Page 2
Compression Male Stud Str. / Elbow	68 / 69	Page 3
Metric Brass Male	68M	Page 3
Compression Pipe Socket	103	Page 3
Compression Hex Plug	109	Page 4
Compression Pipe Reducing Socket	110	Page 4
Compression Female "T" Piece	112	Page 4
Compression Female Elbow	114	Page 4
Compression Female Branch "T"	115	Page 4
Compression Female Cross	116	Page 4
Compression Male / Female 90° Elbow	117	Page 4
Compression Male / Female Adaptor	120	Page 4
Compression Hex Nipple	122	Page 5
Compression Male / Female 45° Elbow	124	Page 5
Compression Pipe Male Run "T" Piece	127	Page 5
Airline Hose Mender	AF	Page 5
Airline Male Hose Connector	AF	Page 5
Brass Barb Tee	828	Page 5
Nylon Tubing - Imperial	N711	Page 6
Nylon Tubing - Metric	N1112	Page 6
PVC Clear re-inforced Hose	7009	Page 6
BLUE POLYESTER TUBING	PU	Page 6



African
Hose
Solutions

Section F | Brass Fittings & Nylon Tubing



069 962 1589



010 065 387 2 / 3 / 4



Admin@AfricanHoseSolutions.co.za



Facebook.com/AfricanHoseSolutions

PIPE CLAMPS

CL

PIPE CLAMPS - SINGLE - POLYPROPYLENE - NORMAL DUTY

Part No.	Price	Size (mm)	Visual
CL06	7.15	6	
CL08	7.15	8	
CL10	7.15	10	
CL12		12	
CL14		14	
CL15		15	
CL16		16	
CL18		18	
CL20		20	
CL22		22	
CL25		25	
CL28		28	
CL30		30	
CL32		32	
CL35		35	
CL38		38	
CL42		42	

CL

PIPE CLAMPS - TWIN - POLYPROPYLENE - NORMAL DUTY



Part No.	Price	Size (mm)	Visual
CD12		6	
CD15		8	
CD16		10	
CD18		12	
CD20		14	
CD22		15	
CD25		16	
CD28		18	

HYDRAULIC LINE TUBE CONNECTORS

W				WE-NPT			
ELBOW FITTING				MALE STUD ELBOW - NPT			
Part No.	Price	Size (mm)	Visual	Part No.	Price	Size (mm)	Visual
W04LL		4		WE06L-1/8NPT		6 x 1/8 NPT	
W06L		6		WE06L-1/4NPT		6 x 1/4 NPT	
W08L		8		WE08L-1/4NPT		8 x 1/4 NPT	
W10L		10		WE10L-3/8NPT		10 x 3/8 NPT	
W12L		12		WE10L-1/4NPT		10 x 1/4 NPT	
W15L		15		WE12L-1/4NPT		12 x 1/4 NPT	
W18L		18		WE12L-3/8NPT		12 x 3/8 NPT	
W22L		22		WE12L-1/2NPT		12 x 1/2 NPT	
W28L		6		WE22L-3/4NPT		22 x 3/4 NPT	
W06S		6		WE28L-1NPT		28 x 1 NPT	
W08S		8		WE06S-1/4NPT		6 x 1/4 NPT	
W10S		10		WE12S-1/2NPT		12 x 1/2 NPT	
W12S		12		WE14S-1/2NPT		14 x 1/2 NPT	
W16S		16		WE16S-1/2NPT		16 x 1/2 NPT	
W20S		20		WE20S-3/4NPT		20 x 3/4 NPT	
W25S		25		WE25S-1NPT		25 x 1 NPT	
W38S		38					

WE-R				WSV			
MALE STUD ELBOW - BSPP				ELBOW BULKHEAD			
Part No.	Price	Size (mm)	Visual	Part No.	Price	Size (mm)	Visual
WE06LR1/8		6 x 1/8 BSPP		WSV06L		6	
WE06LR1/4		6 x 1/4 BSPP		WSV08L		8	
WE08LR1/4		8 x 1/4 BSPP		WSV10L		10	
WE10LR1/4		10 x 1/4 BSPP		WSV12L		12	
WE12LR1/4		12 x 1/4 BSPP		WSV15L		15	
WE12LR3/8		12 x 3/8 BSPP		WSV18L		18	
WE18LR1/2		18 x 1/2 BSPP		WSV10S		10	
WE16SR1/2		16 x 1/2 BSPP		WSV12S		12	
				WSV16S		16	

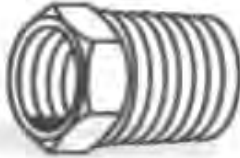
HYDRAULIC LINE TUBE CONNECTORS

RI			MALE/FEMALE REDUCING BUSH			SV			STRAIGHT BULKHEAD		
Part No.	Price	Visual	Part No.	Price	Size (mm)	Visual					
RI1/8X1/4			SV06L		6						
RI1/4X1/8			SV08L		8						
RI1/4X3/8			SV10L		10						
RI1/4X1/2			SV12L		12						
RI1/4X3/4			SV15L		15						
RI3/8X1/8			SV18L		18						
RI3/8X1/4			SV22L		22						
RI3/8X1/2			SV06S		6						
RI1/2X1/4			SV08S		8						
RI1/2X3/8			SV10S		10						
RI1/2X1			SV12S		12						
RI3/4X1/4			SV16S		16						
RI3/4X3/8			SV20S		20						
RI3/4X1/2			SV25S		25						
RI1X1/2											
RI1X3/4											
RI11/4X3/4											
RI11/4X1/2											
RI11/4X1											

T			EQUAL TEES			VSTI			LOCKING COMPONENT - PLUG - BSPP		
Part No.	Price	Size (mm)	Visual	Part No.	Price	Visual					
T06L		6		VSTI1/8ED							
T08L		8		VSTI1/4ED							
T10L		10		VSTI3/8ED							
T12L		12		VSTI1/2ED							
T15L		15		VSTI3/4ED							
T18L		18		VSTI1ED							
T22L		22		VSTI11/4ED							
T28L		6		VSTI11/2ED							
T06S		6		VSTI11/2ED							
T08S		8									
T10S		10									
T12S		12									
T14S		14									
T16S		16									
T20S		20									
T25S		25									
T30S		30									

HYDRAULIC LINE TUBE CONNECTORS

KOR

REDUCING CONNECTIONS

Part No.	Price	Size (mm)	Visual
KOR08/06L			
KOR10/08L			
KOR12/06L			
KOR12/08L			
KOR12/10L			
KOR15/12L			
KOR18/10L			
KOR18/12L			
KOR18/15L			
KOR22/18L			
KOR16/12S			
KOR20/12S			
KOR25/12S			
KOR25/20S			

M

NUTS

MAV

PRESSURE GAUGE CONNECTOR - BSP

Part No.	Price	Size (mm)	Visual	Part No.	Price	Size (mm)	Visual
M06L		6		MAV06LR		6 x 1/8 BSP	
M06LL		6					
M08L		8					
M10L		10					
M12L		12					
M15L		15					
M18L		18					
M22L		22					
M28L		28					
M35L		35					
M42L		42					
M06S		6					
M08S		8					
M10S		10					
M12S		12					
M14S		14					
M16S		16					
M20S		20					
M25S		25					
M30S		30					
M38S		38					



HYDRAULIC LINE TUBE CONNECTORS

GE-MED

STR. MALE STUD COUPLER - METRIC ED

Part No.	Price	Size (mm)	Visual
GE06LMED		6 x M10 x 1	
GE08LMED		8 x M12 x 1.5	
GE10LMED		10 x M14 x 1.5	
GE12LMED		12 x M16 x 1.5	
GE08LM		8 x M12 x 1.5	
GE08LM16X1.5		8 x M16 x 1.5	
GE10LM		10 x M14 x 1.5	
GE10LM16X1.5		10 x M16 x 1.5	
GE10LM18X1.5		10 x M18 x 1.5	
GE12LM		12 x M16 x 1.5	
GE12LM18X1.5		12 x M18 x 1.5	
GE15LM		15 x M18 x 1.5	
GE15LM22X1.5		15 x M22 x 1.5	
GE16SM		16 x M22 x 1.5	

GR

STRAIGHT REDUCING UNION

Part No.	Price	Size (mm)	Visual
GR10/08LGR			
GR12/10LGR			
GR15/12LGR			
GR18/15LGR			
GR22/15LGR			
GR22/18LGR			
GR20/12SGR			

HYDRAULIC LINE TUBE CONNECTORS

GE-R

STRAIGHT MALE STUD COUPLER - BSP

GE-NPT

STRAIGHT MALE STUD COUPLER -NPT

Part No.	Price	Size (mm)	Visual	Part No.	Price	Size (mm)	Visual
GE06LR-1/8		6 x 1/8 BSPP		GE04LL1/8NPT		4 x 1/8 NPT	
GE06LR-1/4		6 x 1/4 BSPP		GE06LL1/8NPT		6 x 1/8 NPT	
GE06LR-3/8		6 x 3/8 BSPP		GE06L1/8NPT		6 x 1/8 NPT	
GE08LR-1/8		8 x 1/8 BSPP		GE06L1/4NPT		6 x 1/4 NPT	
GE08LR-1/4		8 x 1/4 BSPP		GE08L1/8NPT		8 x 1/8 NPT	
GE08LR-3/8		8 x 3/8 BSPP		GE08L1/4NPT		8 x 1/4 NPT	
GE10LR-1/8		10 x 1/8 BSPP		GE08L3/8NPT		8 x 3/8 NPT	
GE10LR-1/4		10 x 1/4 BSPP		GE10L1/4NPT		10 x 1/4 NPT	
GE10LR-3/8		10 x 3/8 BSPP		GE10L3/8NPT		10 x 3/8 NPT	
GE10LR-1/2		10 x 1/2 BSPP		GE10L1/2NPT		10 x 1/2 NPT	
GE12LR-1/4		12 x 1/4 BSPP		GE12L1/4NPT		12 x 1/4 NPT	
GE12LR-3/8		12 x 3/8 BSPP		GE12L3/8NPT		12 x 3/8 NPT	
GE12LR-1/2		12 x 1/2 BSPP		GE12L1/2NPT		12 x 1/2 NPT	
GE15LR-3/8		15 x 3/8 BSPP		GE15L3/8NPT		15 x 3/8 NPT	
GE15LR-1/2		15 x 1/2 BSPP		GE15L1/2NPT		15 x 1/2 NPT	
GE15LR-3/4		15 x 3/4 BSPP		GE18L1/2NPT		18 x 1/2 NPT	
GE18LR-1/2		18 x 1/2 BSPP		GE18L3/4NPT		18 x 3/4 NPT	
GE18LR-3/4		18 x 3/4 BSPP		GE22L1/2NPT		22 x 1/2 NPT	
GE28LR-3/4		28 x 3/4 BSPP		GE22L3/4NPT		22 x 3/4 NPT	
GE28LR-1		28 x 1 BSPP		GE35L11/4NPT		35 x 11/4 NPT	
GE35LR-11/4		35 x 11/4 BSPP		GE35L11/2NPT		35 x 11/2 NPT	
GE08SR-1/4		8 x 1/4 BSPP		GE42L11/2NPT		42 x 11/2 NPT	
GE10SR-3/8		10 x 3/8 BSPP		GE06S1/4NPT		6 x 1/4 NPT	
GE12SR-1/4		12 x 1/4 BSPP		GE08S1/4NPT		8 x 1/4 NPT	
GE12SR-3/8		12 x 3/8 BSPP		GE10S1/4NPT		10 x 1/4 NPT	
GE12SR-1/2		12 x 1/2 BSPP		GE10S3/8NPT		10 x 3/8 NPT	
GE16SR-1/2		16 x 1/2 BSPP		GE12S1/4NPT		12 x 1/4 NPT	
GE16SR-3/8		16 x 3/8 BSPP		GE12S3/8NPT		12 x 3/8 NPT	
GE16SR-3/4		16 x 3/4 BSPP		GE12S1/2NPT		12 x 1/2 NPT	
GE20SR-1/2		20 x 1/2 BSPP		GE14S1/2NPT		14 x 1/2 NPT	
GE20SR-3/4		20 x 3/4 BSPP	GE16S3/8NPT		16 x 3/8 NPT		
GE20SR-1		20 x 1 BSPP	GE16S1/2NPT		16 x 1/2 NPT		
GE25SR-3/4		25 x 3/4 BSPP	GE16S3/4NPT		16 x 3/4 NPT		
GE25SR-1		25 x 1 BSPP	GE20S1/2NPT		20 x 1/2 NPT		
GE30SR-1		30 x 1 BSPP	GE20S3/4NPT		20 x 3/4 NPT		
GE30SR-11/4		30 x 11/4 BSPP	GE25S3/4NPT		25 x 3/4 NPT		
GE35LR-1		35 x 1 BSPP	GE25S1NPT		25 x 1 NPT		
GE38SR-11/2		38 x 11/2 BSPP	GE30S1NPT		30 x 1 NPT		
			GE38S11/2NPT		38 x 11/2 NPT		

HYDRAULIC LINE TUBE CONNECTORS

EVW

ADJUSTABLE ELBOWS

G

STRAIGHT UNION / COUPLING

Part No.	Price	Size (mm)	Visual	Part No.	Price	Size (mm)	Visual
EVW06L		6		G04LL		4	
EVW08L		8		G06LL		6	
EVW10L		10		G08LL		8	
EVW12L		12		G06L		6	
EVW15L		15		G08L		8	
EVW18L		18		G10L		10	
EVW22L		22		G12L		12	
EVW28L		28		G15L		15	
EVW35L		35		G18L		18	
EVW42L		42		G22L		22	
EVW06S		6		G28L		28	
EVW08S		8		G35L		35	
EVW10S		10		G42L		42	
EVW12S		12		G06S		6	
EVW14S		14		G08S		8	
EVW16S		16		G10S		10	
EVW20S		20		G12S		12	
EVW25S		25		G14S		14	
EVW30S		30		G16S		16	
EVW38S		38	G20S		20		
			G25S		25		
			G30S		30		
			G38S		38		

GAI

STRAIGHT FEMALE STUD COUPLINGS - BSP

Part No.	Price	Size (mm)	Visual
GAI06LR		6 x 1/8 BSPP	
GAI08LR		8 x 1/4 BSPP	
GAI10LR		10 x 1/4 BSPP	
GAI12LR		12 x 3/8 BSPP	
GAI18LR		18 x 1/2 BSPP	
GAI06SR		6 x 1/8 BSPP	
GAI08SR		8 x 1/4 BSPP	
GAI10SR		10 x 3/8 BSPP	
GAI12SR		12 x 3/8 BSPP	
GAI14SR		14 x 1/2 BSPP	

HYDRAULIC LINE TUBE CONNECTORS

BUZ

BLANKING PLUGS

Part No.	Price	Size (mm)	Part No.	Price	Size (mm)	Visual
BUZ06L/S		6	BUZ16S		16	
BUZ08L/S		8	BUZ20S		20	
BUZ10L/S		10	BUZ22L		22	
BUZ12L/S		12	BUZ25S		25	
BUZ15L		15	BUZ30S		30	
BUZ18L		18	BUZ38S		38	

D CUTTING RINGS			EVGE-ED			STRAIGHT STUD STANDPIPES (BSPP-ED)	
Part No.	Price	Size (mm)	Visual	Part No.	Price	Size (mm)	Visual
D04LL		4		EVGE06LRED		6 x 1/8 BSPP	
D06L/S		6		EVGE08LRED		8 x 1/4 BSPP	
D08L/S		8		EVGE10LRED		10 x 1/4 BSPP	
D10L/S		10		EVGE12LRED		12 x 3/8 BSPP	
D12L/S		12		EVGE15LRED		15 x 1/2 BSPP	
D15L		15		EVGE18LRED		18 x 1/2 BSPP	
D18L		18		EVGE06SRED		6 x 1/8 BSPP	
D22L		22		EVGE08SRED		8 x 1/4 BSPP	
D28L		28		EVGE10SRED		10 x 3/8 BSPP	
D35L		35		EVGE12SRED		12 x 3/8 BSPP	
D42L		42		EVGE16SRED		16 x 1/2 BSPP	
D14S		14		EVGE20SRED		20 x 3/4 BSPP	
D16S		16					
D20S		20					
D25S		25					
D30S		30					
D35L		35					
D38S		38					

EVL

ADJUSTABLE BARREL RUN TEES

Part No.	Price	Size (mm)	Part No.	Price	Size (mm)	Visual
EVL06L		6	EVL12S		16	
EVL08L		8	EVL16S		16	
EVL10L		10	EVL20S		20	
EVL12L		12	EVL25S		25	
EVL15L		15				
EVL18L		18				
EVL22L		22				

EVT

ADJUSTABLE BRANCH TEES

Part No.	Price	Size (mm)	Part No.	Price	Size (mm)	Visual
EVT06L		6	EVT08S		8	
EVT08L		8	EVT10S		10	
EVT10L		10				
EVT12L		12				
EVT15L		15				
EVT18L		18				

HYDRAULIC STEEL TUBING

DIN 2391, ST37, 4 ANNEALED, PHOSPHATED OILED AND PLUGGED - METRIC TUBE

Size	Price	W.P. in Bars	Visual
6x1		389	 
6x1.5		549	
6x2		692	
8x1		333	
8x1.5		431	
8x2		549	
10x1		282	
10x1.5		373	
12x1		235	
12x1.5		353	
12x2		409	
14x2		403	
15x1		188	
15x1.5		282	
16x1.5		264	
16x2		353	
18x1.5		196	
18x2		313	
20x1.5		194	
20x2		282	
20x2.5		353	
22x1.5		192	
22x2		256	
25x2		276	
25x2.5		282	
25x3		338	
28x2		201	
28x3		302	
30x2.5		235	
30x3		282	
35x3		242	
38x3		223	
38x4		297	
42x3		201	

ZISTA BRAKE TUBING

DIN 74234-B6 - DIN 2394-2/C-94 - STEEL GRADE RST 34.2

Part No.	Price	Size	W.P. in Bars	Visual
BUNDY-03		4.760 x 0.700	299	
BUNDY-04		6.350 x 0.710	239	
BUNDY-06		9.530 x 0.890	220	
BUNDY-08		12.70 x 1.00	190	
BUNDY-06M		6.00 x 0.700	253	
BUNDY-08M		8.00 x 0.700	190	
BUNDY-10M		10.00 x 1.00	236	
BUNDY-12M		12.00 x 1.00	196	

Hydraulic Line Tube Connectors

Steel Tubing & Tube Connectors

Hydraulic Steel Tubing	ST	Page 1
Zista Brake Tubing	BUNDY	Page 1
Blanking Plugs	BUZ_L/S	Page 2
Cutting Rings	D_L/S	Page 2
Straight Stud Standpipes	EVGE-ED	Page 2
Adjustable Barrel Run Tees	EVL	Page 2
Adjustable Branch Tees	EVT	Page 2
Adjustable Elbows	EVW	Page 3
Straight Union/Coupling	G_LL/L/S	Page 3
Straight Female Stud Coupler - BSP	GAI_LR/SR	Page 3
Straight Male Stud Coupler - BSP	GE_LR/SR	Page 4
Straight Male Stud Coupler - NPT	GE_L/S	Page 4
Straight Male Stud Coupler - Metric ED	GE_LMED	Page 5
Straight Reducing Union	GR	Page 5
Reducing Connections	KOR	Page 6
Nuts	M_L	Page 6
Pressure Guage Connector - BSP	MAV_LR/SR	Page 6
Male/Female Reducing Bush	RI	Page 7
Straight BulkHead	SV_L/S	Page 7
Equal Tees	T_L/S	Page 7
Locking Component Plug - BSP	VSTI_ED	Page 7
Elbow Fitting	W_L/S	Page 8
Male Stud Elbow - BSPT	WE_LR	Page 8
Male Stud Elbow - NPT	WE_L/S	Page 8
Elbow BulkHead	WSV_L/S	Page 8
2-Way BSP Female Ball Valves	BKHR	Page 9
Check Valve	VR	Page 9
Pipe Clamps - Single - Polypropylene - Normal Duty	CL	Page 9



African
Hose
Solutions

Section E

Steel Tube & Tube Fittings



069 962 1589



010 065 387 2 / 3 / 4







Admin@AfricanHoseSolutions.co.za

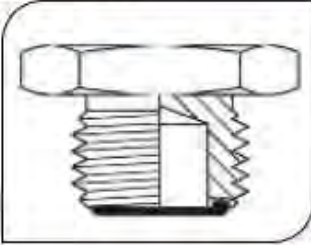

Facebook.com/AfricanHoseSolutions

ORFS ADAPTORS

MCFB				ORFS x BSP - STRAIGHT	
Part No.	Price	ORFS	BSP	Visual	
MCFB-04-02		9/16" -18	1/8"		
MCFB-04-04		9/16" -18	1/4"		
MCFB-04-06		9/16" -18	3/8"		
MCFB-06-04		1 1/16" -16	1/4"		
MCFB-06-06		1 1/16" -16	3/8"		
MCFB-06-08		1 1/16" -16	1/2"		
MCFB-08-04		1 3/16" -16	1/4"		
MCFB-08-06		1 3/16" -16	3/8"		
MCFB-08-08		1 3/16" -16	1/2"		
MCFB-08-12		1 3/16" -16	3/4"		
MCFB-10-08		1" -14	1/2"		
MCFB-12-08		1 3/16" -12	1/2"		
MCFB-12-10		1 3/16" -12	5/8"		
MCFB-12-12		1 3/16" -12	3/4"		
MCFB-12-16		1 3/16" -12	1"		
MCFB-16-12		1 7/16" -12	3/4"		
MCFB-16-16		1 7/16" -12	1"		
MCFB-20-24		1 11/16" -12	1 1/2"		
FFC40XS		ORFS	BSP	ORFS x BSP - 90°	
FFC40XS-04-04		9/16" -18	1/4"		
FFC40XS-06-04		1 1/16" -16	1/4"		
FFC40XS-06-06		1 1/16" -16	3/8"		
FFC40XS-06-08		1 1/16" -16	1/2"		
FFC40XS-08-06		1 3/16" -16	3/8"		
FFC40XS-08-08		1 3/16" -16	1/2"		
FFC40XS-08-12		1 3/16" -16	3/4"		
FFC40XS-12-08		1 3/16" -12	1/2"		
FFC40XS-12-12		1 3/16" -12	3/4"		
FFC40XS-16-16		1 7/16" -12	1"		
FF2408		ORFS MALE PLUG			
FF2408-04		9/16" -18			
FF2408-06		11/16" -16			
FF2408-08		13/16" -16			
FF2408-10		1" -14			
FF2408-12		1 3/16" -12			
FF2408-16		1 7/16" -12			
FF2408-20		1 11/16" -12			
FF2408-24		2" -12			
FF2406		ORFS MALE/FEMALE REDUCING BUSH			
Part No.	Price	ORFS	ORFS	Visual	
FF2406-06-04		1 1/16" -16	9/16" -18		
FF2406-08-04		13/16" -16	9/16" -18		
FF2406-08-06		13/16" -16	11/16" -16		
FF2406-12-08		1 3/16" -12	13/16" -16		
FF2406-12-10		1 3/16" -12	1" -14		
FF2406-16-08		1 7/16" -12	13/16" -16		
FF2406-16-12		1 7/16" -12	1 3/16" -12		
FF2406-20-16		1 11/16" -12	1 7/16" -12		

ORFS ADAPTORS

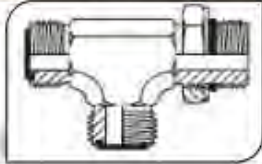
FF6804				ORFS MALE x SAE O' RING MALE RUN TEE
Part No.	Price	ORFS	SAE	Visual
FF6804-04-04-04		9/16"-18	7/16"	
FF6804-06-06-06		1 1/16"-16	9/16"	
FF6804-08-08-08		1 3/16"-16	3/4"	
FF6804-12-12-12		1 3/16"-12	11/16"	
FF6804-16-16-16		1 7/16"-12	1 5/8"	

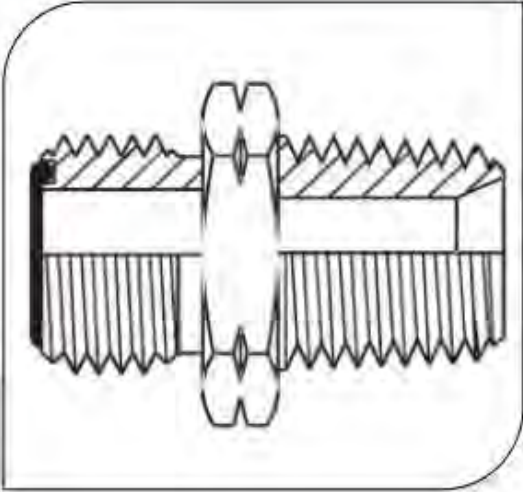
FF2404				ORFS MALE x NPT MALE - STRAIGHT
Part No.	Price	ORFS	NPT	Visual
FF2404-04-02		9/16"-18	1/8"	
FF2404-04-04		9/16"-18	1/4"	
FF2404-04-06		9/16"-18	3/8"	
FF2404-04-08		9/16"-18	1/2"	
FF2404-06-02		1 1/16"-16	1/8"	
FF2404-06-04		1 1/16"-16	1/4"	
FF2404-06-06		1 1/16"-16	3/8"	
FF2404-06-08		1 1/16"-16	1/2"	
FF2404-08-04		1 3/16"-16	1/4"	
FF2404-08-06		1 3/16"-16	3/8"	
FF2404-08-08		1 3/16"-16	1/2"	
FF2404-08-12		1 3/16"-16	3/4"	
FF2404-10-08		1"-14	1/2"	
FF2404-10-12		1"-14	3/4"	
FF2404-12-08		1 3/16"-12	1/2"	
FF2404-12-12		1 3/16"-12	3/4"	
FF2404-12-16		1 3/16"-12	1"	
FF2404-16-12		1 7/16"-12	3/4"	
FF2404-16-16		1 7/16"-12	1"	
FF2404-16-20		1 7/16"-12	1 1/4"	
FF2404-24-24		2"-12	1 1/2"	

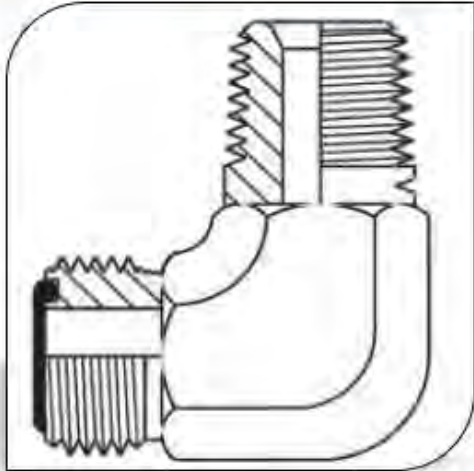

FF2501				ORFS MALE x NPT MALE - 90°
Part No.	Price	ORFS	NPT	Visual
FF2501-04-02		9/16"-18	1/8"	
FF2501-04-04		9/16"-18	1/4"	
FF2501-04-06		9/16"-18	3/8"	
FF2501-06-02		11/16"-16	1/8"	
FF2501-06-04		11/16"-16	1/4"	
FF2501-06-06		11/16"-16	3/8"	
FF2501-06-08		11/16"-16	1/2"	
FF2501-08-06		13/16"-16	3/8"	
FF2501-08-08		13/16"-16	1/2"	
FF2501-08-12		13/16"-16	3/4"	
FF2501-12-08		1 3/16"-12	1/2"	
FF2501-12-12		1 3/16"-12	3/4"	
FF2501-12-16		2 3/16"-12	1"	
FF2501-16-12		1 7/16"-12	3/4"	
FF2501-16-16		1 7/16"-12	1"	

ORFS ADAPTORS

FF6802

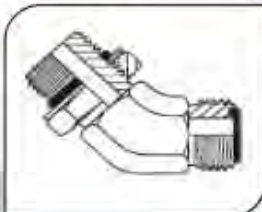
ORFS MALE x SAE O' RING MALE - 45°

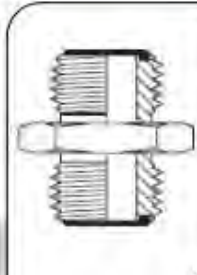
Part No.	Price	ORFS	SAE	Visual
FF6802-04-04		9/16"-18	7/16"	
FF6802-06-06		11/16"-16	9/16"	
FF6802-06-08		11/16"-16	3/4"	
FF6802-08-08		13/16"-16	3/4"	
FF6802-10-10		1"-14	7/8"	
FF6802-12-12		1 3/16"-12	11/16"	
FF6802-16-16		1 7/16"-12	1 5/6"	

FF2403 ORFS MALE NIPPLE				FF304C ORFS FEMALE CAP			
Part No.	Price	ORFS	Visual	Part No.	Price	ORFS	Visual
FF2403-04-04		9/16"-18		FF304C-04		9/16"-18	
FF2403-06-04		11/16"-16					
FF2403-06-06		11/16"-16					
FF2403-08-08		13/16"-16					
FF2403-10-08							
FF2403-10-10		1"-14					
FF2403-12-10		-12 to -10					
FF2403-12-12		1 3/16"-12					
FF2403-16-16		1 7/16"-12					
FF2403-20-20		1 11/16"-12					
FF2403-24-24		2"-12					
				FF304C-06		11/16"-16	
			FF304C-08		13/16"-16		
			FF304C-10		1"-14		
			FF304C-12		1 3/16"-12		
			FF304C-16		1 7/16"-12		
			FF304C-20		1 11/16"-12		
			FF304C-24		2"-12		

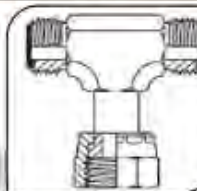
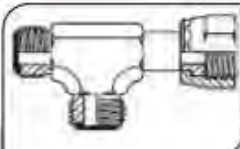

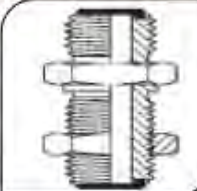

FF6600 ORFS BRANCH TEE				FF6602 ORFS RUN TEE			
Part No.	Price	ORFS	Visual	Part No.	Price	ORFS	Visual
FF6600-04-04-04		9/16"-18		FF6602-04-04-04		9/16"-18	
FF6600-06-06-06		11/16"-16					
FF6600-08-08-08		13/16"-16					
FF6600-10-10-10		1"-14					
FF6600-12-12-12		1 3/16"-12					
FF6600-16-16-16		1 7/16"-12					
			FF6602-06-06-06		11/16"-16		
			FF6602-08-08-08		13/16"-16		
			FF6602-10-10-10		1"-14		
			FF6602-12-12-12		1 3/16"-12		
			FF6602-16-16-16		1 7/16"-12		

FF2700 ORFS BULKHEAD - STRAIGHT				FF2701 ORFS BULKHEAD - 90°			
Part No.	Price	ORFS	Visual	Part No.	Price	ORFS	Visual
FF2700-04-04		9/16"-18		FF2701-04-04		9/16"-18	
FF2700-06-06		11/16"-16					
FF2700-08-08		13/16"-16					
FF2700-10-10		1"-14					
FF2700-12-12		1 3/16"-12					
FF2700-16-16		1 7/16"-12					
				FF2701-06-06		11/16"-16	
			FF2701-08-08		13/16"-16		
			FF2701-10-10		1"-14		
			FF2701-12-12		1 3/16"-12		

FF6803				ORFS x SAE MALE BRANCH 'T'	
Part No.	Price	ORFS	SAE	Visual	
FF6803-04-04-04		9/16"-18	7/16"		
FF6803-06-06-06		11/16"-16	9/16"		
FF6803-08-08-08		13/16"-16	3/4"		
FF6803-12-12-12		1 3/16"-12	11/16"		

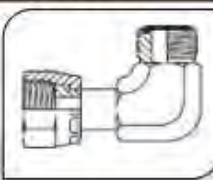

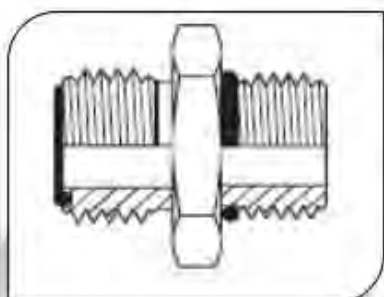

ORFS ADAPTORS



FF6500		ORFS 90° MALE/FEMALE		FF6502		ORFS 45° MALE/FEMALE	
FF6500-04-04		9/16" -18		FF6502-04-04		9/16" -18	
FF6500-06-06		11/16" -16		FF6502-06-06		11/16" -16	
FF6500-08-08		13/16" -16		FF6502-08-08		13/16" -16	
FF6500-10-10		1" -14		FF6502-10-10		1" -14	
FF6500-12-12		1 3/16" -12		FF6502-12-12		1 3/16" -12	
FF6500-16-16		1 7/16" -12		FF6502-16-16		1 7/16" -12	
Part No.	Price	ORFS	SAE	FF6400 - ORFS MALE x SAE O' RING MALE - STRAIGHT			
FF6400-04-04		9/16"-18	7/16"				
FF6400-04-05		9/16"-18	1/2"				
FF6400-04-06		9/16"-18	9/16"				
FF6400-04-08		9/16"-18	3/4"				
FF6400-06-04		11/16"-16	7/16"				
FF6400-06-06		11/16"-16	9/16"				
FF6400-06-08		11/16"-16	3/4"				
FF6400-06-10		11/16"-16	7/8"				
FF6400-08-06		13/16"-16	9/16"				
FF6400-08-08		13/16"-16	3/4"				
FF6400-08-10		13/16"-16	7/8"				
FF6400-08-12		13/16"-16	1 1/16"				
FF6400-10-08		1" -14	3/4"				
FF6400-10-10		1" -14	7/8"				
FF6400-10-12		1" -14	1 1/16"				
FF6400-12-08		1 3/16"-12	3/4"				
FF6400-12-10		1 3/16"-12	7/8"				
FF6400-12-12		1 3/16"-12	1 1/16"				
FF6400-12-16		1 3/16"-12	1 5/16"				
FF6400-16-12		1 7/16"-12	1 1/16"				
FF6400-16-16		1 7/16"-12	1 5/16"				
FF6400-16-20		1 7/16"-12	1 5/8"				
FF6400-20-20		1 11/16"-12	1 5/8"				
Part No.	Price	ORFS	SAE	FF6801 - ORFS MALE x SAE O' RING MALE - 90°			
FF6801-04-04		9/16"-18	7/16"	Visual			
FF6801-06-04		11/16"-16	7/16"				
FF6801-06-06		11/16"-16	9/16"				
FF6801-06-08		11/16"-16	3/4"				
FF6801-06-10		11/16"-16	3/4"				
FF6801-08-06		13/16"-16	9/16"				
FF6801-08-08		13/16"-16	3/4"				
FF6801-08-10		13/16"-16	1 1/16"				
FF6801-08-12		13/16"-16	1 1/16"				
FF6801-10-08		1" -14	3/4"				
FF6801-10-10		1" -14	7/8"				
FF6801-10-12		1" -14	1 1/16"				
FF6801-12-08		1 3/16"-12	3/4"				
FF6801-12-10		1 3/16"-12	1 1/16"				
FF6801-12-12		1 3/16"-12	1 1/16"				
FF6801-12-16		1 3/16"-12	1 5/16"				
FF6801-16-12		1 7/16"-12	1 1/16"				
FF6801-16-16		1 7/16"-12	1 5/16"				

PLUGS

2408			JIC PLUG
Part No.	Price	JIC	Visual
2408-04		7/16"	
2408-05		1/2"	
2408-06		9/16"	
2408-08		3/4"	
2408-10		7/8"	
2408-12		1 1/16"	
2408-16		1 5/16"	
2408-20		1 5/8"	
2408-24		1 7/8"	
2408-32		2 1/2"	

5406P			NPT PLUG
Part No.	Price	NPT	Visual
5406P-02		1/8"	
5406P-04		1/4"	
5406P-06		3/8"	
5406P-08		1/2"	
5406P-12		3/4"	
5406P-16		1"	
5406P-20		1 1/4"	
5406P-24		1 1/2"	
5406P-32		2"	

HPB			BSP PLUG
Part No.	Price	SIZE	Visual
HPB-02		1/8"	
HPB-04		1/4"	
HPB-06		3/8"	
HPB-08		1/2"	
HPB-10		5/8"	
HPB-12		3/4"	
HPB-16		1"	
HPB-20		1 1/4"	
HPB-24		1 1/2"	
HPB-32		2"	

6408P				6409			
SAE PLUG		SAE PLUG - ALLEN KEY TYPE					
Part No.	Price	SAE	Visual	Part No.	Price	SAE	Visual
6408P-04		7/16"		6409-04		7/16"	
6408P-05		1/2"					
6408P-06		9/16"					
6408P-08		3/4"					
6408P-10		7/8"					
6408P-12		1 1/16"					
6408P-16		1 5/16"					
6408P-20		1 5/8"					
6408P-24		1 7/8"					

JIC ADAPTORS

2406

JIC MALE/FEMALE REDUCING BUSH

Part No.	Price	JIC	JIC	Visual
2406-06-04		9/16"	7/16"	
2406-08-04		3/4"	7/16"	
2406-08-06		3/4"	9/16"	
2406-10-06		7/8"	9/16"	
2406-10-08		7/8"	1/2"	
2406-10-12		7/8"	3/4"	
2406-12-06		1 1/16"	9/16"	
2406-12-08		1 1/16"	3/4"	
2406-12-10		1 1/16"	7/8"	
2406-16-08		1 5/16"	3/4"	
2406-16-12		1 5/16"	1 1/16"	
2406-20-16		1 5/8"	1 5/16"	
2406-24-20		1 7/8"	1 5/8"	

318

TUBE NUT (FLARE NUT)

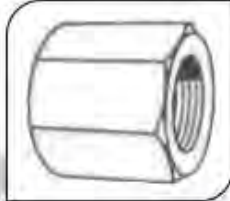

Part No.	Price	JIC	Visual
318-04		7/16"	
318-05		5/16"	
318-06		9/16"	
318-08		3/4"	
318-10		7/8"	
318-12		1 1/16"	
318-16		1 5/16"	
318-20		1 5/8"	



319

FERRULES (SLEEVES)

Part No.	Price	JIC	Visual
319-04		7/16"	
319-05		5/16"	
319-06		9/16"	
319-08		3/4"	
319-10		7/8"	
319-12		1 1/16"	
319-16		1 5/16"	

JIC ADAPTORS

6502 JIC MALE x JIC FEMALE 45°				2603 JIC MALE 'T' PIECE			
Part No.	Price	JIC	Visual	Part No.	Price	JIC	Visual
6502-04-04		7/16"		2603-04-04-04		7/16"	
6502-05-05		1/2"		2603-05-05-05		5/16"	
6502-06-06		9/16"		2603-06-06-06		9/16"	
6502-08-08		3/4"		2603-08-08-08		3/4"	
6502-10-10		7/8"		2603-10-10-10		7/8"	
6502-12-12		1 1/16"		2603-12-12-12		1 1/16"	
6502-16-16		1 5/16"		2603-16-16-16		1 5/16"	
6502-20-20		1 5/8"		2603-20-20-20		1 5/8"	
6502-24-24		1 7/8"					
6502-32-32		2 1/2"					



6600 JIC MALE/FEMALE BRANCH 'T'				6602 JIC FEMALE RUN 'T'			
Part No.	Price	JIC	Visual	Part No.	Price	JIC	Visual
6600-04-04-04		7/16"		6602-04-04-04		7/16"	
6600-05-05-05		5/16"		6602-05-05-05		5/16"	
6600-06-06-06		9/16"		6602-06-06-06		9/16"	
6600-08-08-08		3/4"		6602-08-08-08		3/4"	
6600-10-10-10		7/8"		6602-10-10-10		7/8"	
6600-12-12-12		1 1/16"		6602-12-12-12		1 1/16"	
6600-16-16-16		1 5/16"		6602-16-16-16		1 5/16"	
6600-20-20-20		1 5/8"		6602-20-20-20		1 5/8"	
				6602-24-24-24		1 7/8"	

2700 JIC BULKHEAD STR (INCL. LOCKNUT)				2701 JIC BULKHEAD 90° (INCL. LOCKNUT)			
Part No.	Price	JIC	Visual	Part No.	Price	JIC	Visual
2700-04-04		7/16"		2701-04-04		7/16"	
2700-05-05		1/2"		2701-05-05		1/2"	
2700-06-06		9/16"		2701-06-06		9/16"	
2700-08-08		3/4"		2701-08-08		3/4"	
2700-10-10		7/8"		2701-10-10		7/8"	
2700-12-12		1 1/16"		2701-12-12		1 1/16"	
2700-16-16		1 5/16"		2701-16-16		1 5/16"	
2700-20-20		1 5/8"		2701-20-20		1 5/8"	
2700-24-24		1 7/8"					

0306 LOCKNUT				304C JIC CAP			
Part No.	Price	JIC	Visual	Part No.	Price	JIC	Visual
0306-04		7/16"		304C-04		7/16"	
0306-05		1/2"		304C-05		5/16"	
0306-06		9/16"		304C-06		9/16"	
0306-08		3/4"		304C-08		3/4"	
0306-10		7/8"		304C-10		7/8"	
0306-12		1 1/16"		304C-12		1 1/16"	
0306-16		1 5/16"		304C-16		1 5/16"	
0306-20		1 5/8"		304C-20		1 5/8"	
0306-24		1 7/8"		304C-24		1 7/8"	
				304C-32		2 1/2"	

JIC ADAPTORS

6801				JIC MALE x SAE O' RING MALE - 90°			
Part No.	Price	JIC	SAE	Visual			
6801-04-04		7/16"	7/16"				
6801-04-05		7/16"	1/2"				
6801-04-06		7/16"	9/16"				
6801-04-08		7/16"	3/4"				
6801-05-04		1/2"	7/16"				
6801-05-05		1/2"	1/2"				
6801-05-06		1/2"	9/16"				
6801-06-04		9/16"	7/16"				
6801-06-05		9/16"	1/2"				
6801-06-06		9/16"	9/16"				
6801-06-08		9/16"	3/4"				
6801-06-10		9/16"	7/8"				
6801-08-06		3/4"	9/16"				
6801-08-08		3/4"	3/4"				
6801-08-10		3/4"	7/8"				
6801-08-12		3/4"	11/16"				
6801-10-08		7/8"	3/4"				
6801-10-10		7/8"	7/8"				
6801-10-12		7/8"	11/16"				
6801-12-08		11/16"	3/4"				
6801-12-10		11/16"	7/8"				
6801-12-12		11/16"	11/16"				
6801-12-12L		11/16"	11/16"				
6801-12-12LL		11/16"	11/16"				
6801-12-16		11/16"	15/16"				
6801-16-12		1 5/16"	1 1/16"				
6801-16-16		1 5/6"	1 5/6"				
6801-16-20		1 5/6"	1 5/8"				
6801-20-16		1 5/8"	1 5/16"				
6801-20-20		1 5/8"	1 5/8"				
6801-20-24		1 5/8"	1 7/8"				
6801-24-20		1 7/8"	1 5/8"				
6801-24-24		1 7/8"	1 7/8"				
6801-32-32		2 1/2"	2 1/2"				

6504				6500			
JIC MALE x JIC FEMALE STRAIGHT				JIC MALE x JIC FEMALE 90°			
Part No.	Price	JIC	Visual	Part No.	Price	JIC	Visual
6504-04-04		7/16"		6500-04-04		7/16"	
6504-06-06		9/16"		6500-05-05		1/2"	
6504-08-08		3/4"		6500-06-06		9/16"	
6504-10-10		7/8"		6500-08-08		3/4"	
6504-12-12		1 1/16"		6500-10-10		7/8"	
6504-16-16		1 5/16"		6500-12-08		11/16 - 3/4"	
6504-20-20		1 5/8"		6500-12-12		11/16"	
				6500-16-16		15/16"	
			6500-20-20		15/8"		
			6500-24-24		17/8"		
			6500-32-32		21/2"		

JIC ADAPTORS

6400

JIC MALE x SAE O' RING MALE - STRAIGHT

Part No.	Price	JIC	SAE	Visual
6400-04-04		7/16"	7/16"	
6400-04-05		7/16"	1/2"	
6400-04-06		7/16"	9/16"	
6400-04-08		7/16"	3/4"	
6400-05-04		1/2"	7/16"	
6400-05-05		1/2"	1/2"	
6400-05-06		1/2"	9/16"	
6400-06-04		9/16"	7/16"	
6400-06-05		9/16"	1/2"	
6400-06-06		9/16"	9/16"	
6400-06-08		9/16"	3/4"	
6400-06-10		9/16"	7/8"	
6400-06-12		9/16"	11/16"	
6400-08-04		3/4"	7/16"	
6400-08-06		3/4"	9/16"	
6400-08-08		3/4"	3/4"	
6400-08-10		3/4"	7/8"	
6400-08-12		3/4"	11/16"	
6400-08-16		3/4"	15/16"	
6400-10-06		7/8"	9/16"	
6400-10-08		7/8"	3/4"	
6400-10-10		7/8"	7/8"	
6400-10-12		7/8"	11/16"	
6400-12-06		11/16"	9/16"	
6400-12-08		11/16"	3/4"	
6400-12-10		11/16"	7/8"	
6400-12-12		11/16"	11/16"	
6400-12-16		11/16"	15/16"	
6400-16-10		1 5/16"	7/8"	
6400-16-12		1 5/16"	1 1/16"	
6400-16-16		1 5/6"	1 5/6"	
6400-16-20		1 5/6"	1 5/8"	
6400-20-16		1 5/8"	1 5/16"	
6400-20-20		1 5/8"	1 5/8"	
6400-20-24		1 5/8"	1 7/8"	
6400-24-20		1 7/8"	1 5/8"	
6400-24-24		1 7/8"	1 7/8"	
6400-32-32		2 1/2"	2 1/2"	

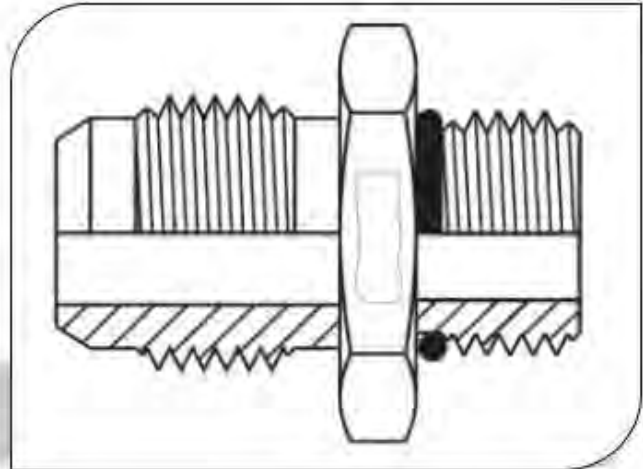

JIC ADAPTORS

JM_mm

JIC X METRIC - STRAIGHT

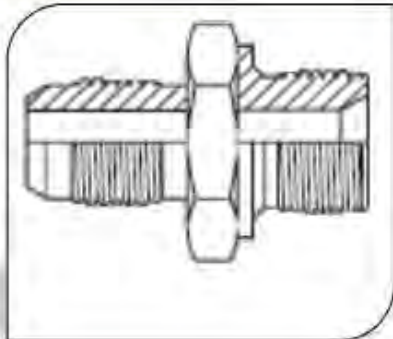
Part No.	Price	JIC	METRIC	Visual
4JM12MM		7/16"	12mm	
4JM14MM		7/16"	14mm	
4JM16MM		7/16"	16mm	
6JM12MM		9/16"	12mm	
6JM14MM		9/16"	14mm	
6JM16MM		9/16"	16mm	
6JM18MM		9/16"	18mm	
8JM14MM		3/4"	14mm	
8JM16MM		3/4"	16mm	
8JM18MM		3/4"	18mm	
8JM22MM		3/4"	22mm	
8JM26MM		3/4"	26mm	

6802

JIC MALE x SAE O' RING - 45°

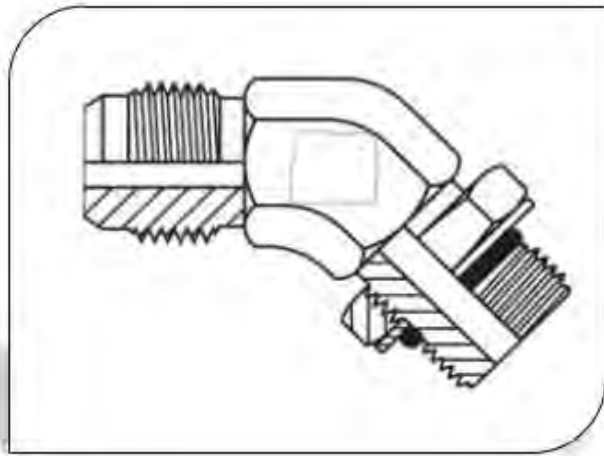
Part No.	Price	JIC	METRIC	Visual
6802-04-04		7/16"	7/16"	
6802-05-05		1/2"	1/2"	
6802-06-04		9/16"	7/16"	
6802-06-06		9/16"	9/16"	
6802-06-08		9/16"	3/4"	
6802-08-06		3/4"	9/16"	
6802-08-08		3/4"	3/4"	
6802-08-10		3/4"	7/8"	
6802-08-12		3/4"	11/16"	
6802-10-08		7/8"	3/4"	
6802-10-10		7/8"	7/8"	
6802-10-12		7/8"	11/16"	
6802-12-08		11/16"	3/4"	
6802-12-10		11/16"	7/8"	
6802-12-12		11/16"	11/16"	
6802-12-16		11/16"	15/16"	
6802-16-16		15/16"	15/16"	
6802-20-20		15/8"	15/8"	
6802-24-24		17/8"	17/8"	

JIC ADAPTORS

2403

JIC ADAPTOR - STRAIGHT

Part No.	Price	JIC	JIC	Visual
2403-04-04		7/16"	7/16"	
2403-05-04		1/2"	7/16"	
2403-05-05		1/2"	1/2"	
2403-06-04		9/16"	7/16"	
2403-06-05		9/16"	1/2"	
2403-06-06		9/16"	9/16"	
2403-08-06		3/4"	9/16"	
2403-08-08		3/4"	3/4"	
2403-10-08		7/8"	3/4"	
2403-10-10		7/8"	7/8"	
2403-12-08		11/16"	3/4"	
2403-12-10		7/8"	11/16"	
2403-12-12		11/16"	11/16"	
2403-16-12		15/16"	11/16"	
2403-16-16		15/16"	15/16"	
2403-20-16		15/8"	15/16"	
2403-20-20		15/8"	15/8"	
2403-24-20		17/8"	15/8"	
2403-24-24		17/8"	17/8"	
2403-32-32		21/2"	21/2"	

2500

JIC ADAPTOR - 90°

Part No.	Price	JIC	JIC	Visual
2500-04-04		7/16"	7/16"	
2500-05-05		1/2"	1/2"	
2500-06-06		9/16"	9/16"	
2500-08-08		3/4"	3/4"	
2500-10-10		7/8"	7/8"	
2500-12-12		1 1/16"	1 1/16"	
2500-16-16		1 5/16"	1 5/16"	
2500-20-20		1 5/8"	1 5/8"	
2500-24-24		17/8"	17/8"	

JIC TO NPT ADAPTORS

2601				JIC/NPT BRANCH TEE
Part No.	Price	JIC	NPT	Visual
2601-04-04-04		7/16"	1/4"	
2601-06-06-04		9/16"	1/4"	
2601-06-06-06		9/16"	3/8"	
2601-08-08-06		3/4"	3/8"	
2601-08-08-08		3/4"	1/2"	
2601-12-12-12		1 1/16"	3/4"	
2601-16-16-16		1 5/16"	1"	

2605				JIC/NPT RUN TEE
Part No.	Price	JIC	NPT	Visual
2605-04-04-04		7/16"	1/4"	
2605-06-06-04		9/16"	1/4"	
2605-06-06-06		9/16"	3/8"	
2605-08-08-06		3/4"	3/8"	
2605-08-08-08		3/4"	1/2"	
2605-12-12-12		1 1/16"	3/4"	
2605-16-16-16		1 1/16"	3/4"	

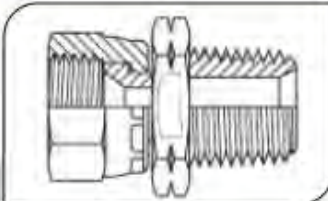
6505				JIC FEMALE SWIVEL x NPT MALE - STRAIGHT
Part No.	Price	JIC	NPT	Visual
6505-04-04		7/16"	1/4"	
6505-04-06		7/16"	3/8"	
6505-06-04		9/16"	1/4"	
6505-06-06		9/16"	3/8"	
6505-08-08		3/4"	1/2"	
6505-12-12		1 1/16"	3/4"	
6505-16-16		1 5/16"	1"	

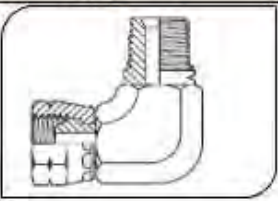
6501				JIC FEMALE SWIVEL x NPT MALE - 90°
Part No.	Price	JIC	NPT	Visual
6501-04-04		7/16"	1/4"	
6501-06-06		9/16"	3/8"	
6501-08-08		3/4"	1/2"	
6501-12-12		1 1/16"	3/4"	
6501-16-16		1 5/16"	1"	
6501-20-20		1 5/8"	1 1/4"	

6506				JIC FEMALE SWIVEL x NPT FEMALE - STRAIGHT
Part No.	Price	JIC	NPT	Visual
6506-04-04		7/16"	1/4"	
6506-06-04		9/16"	1/4"	
6506-06-06		9/16"	3/8"	
6506-08-06		3/4"	3/8"	
6506-08-08		3/4"	1/2"	
6506-12-12		1 1/16"	3/4"	
6506-12-16		1 1/16"	1"	
6506-16-16		1 5/16"	1"	

JIC TO NPT ADAPTORS

2503

JIC MALE x NPT MALE - 45°

Part No.	Price	JIC	NPT	Visual
2503-04-02		7/16"	1/8"	
2503-04-04		7/16"	1/4"	
2503-04-06		7/16"	3/8"	
2503-05-02		1/2"	1/8"	
2503-05-04		1/2"	1/4"	
2503-06-02		9/16"	1/8"	
2503-06-04		9/16"	1/4"	
2503-06-06		9/16"	3/8"	
2503-06-08		9/16"	1/2"	
2503-08-04		3/4"	1/4"	
2503-08-06		3/4"	3/8"	
2503-08-08		3/4"	1/2"	
2503-08-12		3/4"	3/4"	
2503-10-06		7/8"	3/8"	
2503-10-08		7/8"	1/2"	
2503-10-12		7/8"	3/4"	
2503-12-08		1 1/16"	1/2"	
2503-12-12		1 1/16"	3/4"	
2503-12-16		1 1/16"	1"	
2503-16-12		1 5/16"	3/4"	
2503-16-16		1 5/16"	1"	
2503-16-20		1 5/16"	1 1/4"	
2503-20-16		1 5/8"	1"	
2503-20-20		1 5/8"	1 1/4"	
2503-24-24		1 7/8"	1 1/2"	
2503-32-32		2 1/2"	2"	



2405

JIC MALE x NPT FEMALE FIXED - STRAIGHT

Part No.	Price	JIC	NPT	Visual
2405-04-04		7/16"	1/8"	
2405-06-04		7/16"	1/4"	
2405-06-06		7/16"	3/8"	
2405-08-06		1/2"	1/8"	
2405-08-08		1/2"	1/4"	
2405-12-12		9/16"	1/8"	
2405-16-16		1 5/16"	1"	



2502

JIC MALE x NPT FEMALE FIXED - 90°

Part No.	Price	JIC	NPT	Visual
2502-04-04		7/16"	1/4"	
2502-06-06		9/16"	3/8"	
2502-08-08		3/4"	1/2"	
2502-12-12		1 1/16"	3/4"	
2502-16-16		1 5/16"	1"	



JIC TO NPT ADAPTORS

2501

JIC MALE x NPT MALE - 90°

Part No.	Price	JIC	NPT	Visual
2501-04-02		7/16"	1/8"	
2501-04-04		7/16"	1/4"	
2501-04-06		7/16"	3/8"	
2501-04-08		7/16"	1/2"	
2501-05-02		1/2"	1/8"	
2501-05-04		1/2"	1/4"	
2501-06-02		9/16"	1/8"	
2501-06-04		9/16"	1/4"	
2501-06-06		9/16"	3/8"	
2501-06-08		9/16"	1/2"	
2501-06-12		9/16"	3/4"	
2501-08-04		3/4"	1/4"	
2501-08-06		3/4"	3/8"	
2501-08-08		3/4"	1/2"	
2501-08-08L		3/4"	1/2"	
2501-08-08LL		3/4"	1/2"	
2501-08-12		3/4"	3/4"	
2501-10-06		7/8"	3/8"	
2501-10-08		7/8"	1/2"	
2501-10-12		7/8"	3/4"	
2501-12-08		1 1/16"	1/2"	
2501-12-12		1 1/16"	3/4"	
2501-12-12L		1 1/16"	3/4"	
2501-12-12LL		1 1/16"	3/4"	
2501-12-16		1 1/16"	1"	
2501-16-08		1 5/16"	1/2"	
2501-16-12		1 5/16"	3/4"	
2501-16-16		1 5/16"	1"	
2501-16-20		1 5/16"	1 1/4"	
2501-20-16		1 5/8"	1"	
2501-20-20		1 5/8"	1 1/4"	
2501-20-24		2 5/8"	1 7/8"	
2501-24-20		1 7/8"	1 1/4"	
2501-24-24		1 7/8"	1 1/2"	
2501-32-32		2 1/2"	2"	

JIC TO NPT ADAPTORS

2404

JIC MALE x NPT MALE - STRAIGHT

Part No.	Price	JIC	NPT	Visual
2404-04-02		7/16"	1/8"	
2404-04-04		7/16"	1/4"	
2404-04-06		7/16"	3/8"	
2404-04-08		7/16"	1/2"	
2404-05-02		1/2"	1/8"	
2404-05-04		1/2"	1/4"	
2404-05-06		1/2"	3/8"	
2404-06-02		9/16"	1/8"	
2404-06-04		9/16"	1/4"	
2404-06-06		9/16"	3/8"	
2404-06-08		9/16"	1/2"	
2404-06-12		9/16"	3/4"	
2404-08-04		3/4"	1/4"	
2404-08-06		3/4"	3/8"	
2404-08-08		3/4"	1/2"	
2404-08-12		3/4"	3/4"	
2404-08-16		3/4"	1"	
2404-10-06		7/8"	3/8"	
2404-10-08		7/8"	1/2"	
2404-10-12		7/8"	3/4"	
2404-12-06		1 1/16"	3/8"	
2404-12-08		1 1/16"	1/2"	
2404-12-12		1 1/16"	3/4"	
2404-12-16		1 1/16"	1"	
2404-12-20		1 1/16"	1 1/4"	
2404-16-08		1 5/16"	1/2"	
2404-16-12		1 5/16"	3/4"	
2404-16-16		1 5/16"	1"	
2404-16-20		1 5/16"	1 1/4"	
2404-16-24		1 5/16"	1 1/2"	
2404-20-16		1 5/8"	1"	
2404-20-20		1 5/8"	1 1/4"	
2404-20-24		1 5/8"	1 1/2"	
2404-24-16		1 7/8"	1"	
2404-24-20		1 7/8"	1 1/4"	
2404-24-24		1 7/8"	1 1/2"	
2404-24-32		1 7/8"	2"	
2404-32-32		2 1/2"	2"	

NPT ADAPTORS

5406

NPT REDUCER

Part No.	Price	NPT	NPT	Visual
5406-04-02		1/4"	1/8"	
5406-06-02		3/8"	1/8"	
5406-06-04		3/8"	1/4"	
5406-08-02		1/2"	1/8"	
5406-08-04		1/2"	1/4"	
5406-08-06		1/2"	3/8"	
5406-12-04		3/4"	1/4"	
5406-12-06		3/4"	3/8"	
5406-12-08		3/4"	1/2"	
5406-16-04		1"	1/4"	
5406-16-06		1"	3/8"	
5406-16-08		1"	1/2"	
5406-16-12		1"	3/4"	
5406-20-08		1 1/4"	1/2"	
5406-20-12		1 1/4"	3/4"	
5406-20-16		1 1/4"	1"	
5406-24-12		1 1/2"	3/4"	
5406-24-16		1 1/2"	1"	
5406-24-20		1 1/2"	1 1/4"	
5406-32-16		2"	1"	
5406-32-20		2"	1 1/4"	
5406-32-24		2"	1 1/2"	

NPT ADAPTORS

5405

NPT MALE/FEMALE STRAIGHT

Part No.	Price	NPT	NPT	Visual
5405-02-04		1/8"	1/4"	
5405-04-04		1/4"	1/4"	
5405-04-06		1/4"	3/8"	
5405-06-08		3/8"	1/2"	
5405-08-04		1/2"	1/4"	
5405-08-06		1/2"	3/8"	
5405-08-08		1/2"	1/2"	
5405-12-08		3/4"	1/2"	
5405-12-12		3/4"	3/4"	

5502

NPT MALE/FEMALE FIXED ELBOW



Part No.	Price	NPT	NPT	Visual
5502-02-02		1/8"	1/8"	
5502-04-04		1/4"	1/4"	
5502-06-06		3/8"	3/8"	
5502-08-08		1/2"	1/2"	
5502-12-12		3/4"	3/4"	
5502-16-16		1"	1"	
5502-20-20		1 1/4"	1 1/4"	
5502-24-24		1 1/2"	1 1/2"	
5502-32-32		2"	2"	

5602

NPT RUN 'T'

5604

NPT BRANCH 'T'

Part No.	Price	NPT	Visual	Part No.	Price	NPT	Visual
5602-02-02-02		1/8"		5604-02-02-02		1/8"	
5602-04-04-04		1/4"		5604-04-04-04		1/4"	
5602-06-06-06		3/8"		5604-06-06-06		3/8"	
5602-08-08-08		1/2"		5604-08-08-08		1/2"	
5602-12-12-12		3/4"		5604-12-12-12		3/4"	
5602-16-16-16		1"		5604-16-16-16		1"	
5602-20-20-20		1 1/4"		5604-20-20-20		1 1/4"	
5602-24-24-24		1 1/2"					

NPT ADAPTORS

5000

NPT SOCKET - STRAIGHT

Part No.	Price	NPT	NPT	Visual
5000-02-02		1/8"	1/8"	
5000-04-02		1/4"	1/8"	
5000-04-04		1/4"	1/4"	
5000-06-04		3/8"	1/4"	
5000-06-06		3/8"	3/8"	
5000-08-04		1/2"	1/4"	
5000-08-06		1/2"	3/8"	
5000-08-08		1/2"	1/2"	
5000-12-08		3/4"	1/2"	
5000-12-12		3/4"	3/4"	
5000-16-08		1"	1/2"	
5000-16-12		1"	3/4"	
5000-16-16		1"	1"	
5000-20-20		1 1/4"	1 1/4"	
5000-24-24		1 1/2"	1 1/2"	
5000-32-32		2"	2"	

5504

NPT SOCKET - 90°



Part No.	Price	NPT	NPT	Visual
5504-02-02		1/8"	1/8"	
5504-04-04		1/4"	1/4"	
5504-06-06		3/8"	3/8"	
5504-08-08		1/2"	1/2"	
5504-12-12		3/4"	3/4"	
5504-16-16		1"	1"	
5504-20-20		1 1/4"	1 1/4"	
5504-24-24		1 1/2"	1 1/2"	
5504-32-32		2"	2"	

5605

NPT SOCKET - TEES

5652

NPT SOCKET - FEMALE CROSS

Part No.	Price	NPT	Visual	Part No.	Price	NPT	Visual
5605-02-02-02		1/8"		5652-02		1/8"	
5605-04-04-04		1/4"		5652-04		1/4"	
5605-06-06-06		3/8"		5652-06		3/8"	
5605-08-08-08		1/2"		5652-08		1/2"	
5605-12-12-12		3/4"		5652-12		3/4"	
5605-16-16-16		1"		5652-16		1"	
5605-20-20-20		1 1/4"					
5605-24-24-24		1 1/2"					
5605-32-32-32		2"					

NPT ADAPTORS

1503				MALE NPT x FEMALE SWIVEL NPT 45°	
Part No.	Price	NPT M	NPT F	Visual	
1503-02-02		1/8"	1/8"		
1503-04-04		1/4"	1/4"		
1503-06-06		3/8"	3/8"		
1503-08-06		1/2"	3/8"		
1503-08-08		1/2"	1/2"		
1503-12-08		3/4"	1/2"		
1503-12-12		3/4"	3/4"		
1503-16-12		1"	3/4"		
1503-16-16		1"	1"		
1503-20-20		1 1/4"	1 1/4"		
1503-24-24		1 1/2"	1 1/2"		
1503-32-32		2"	2"		

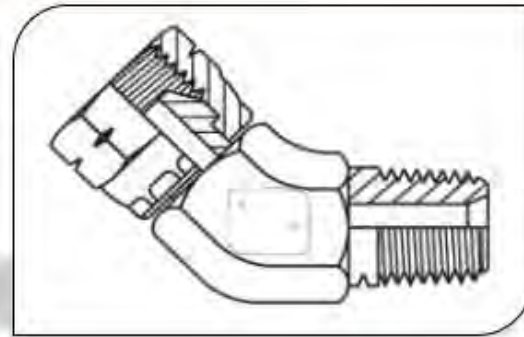

5404				NPT MALE - STRAIGHT	
Part No.	Price	NPT M	NPT M	Visual	
5404-02-02		1/8"	1/8"		
5404-04-02		1/4"	1/8"		
5404-04-04		1/4"	1/4"		
5404-06-02		3/8"	1/8"		
5404-06-04		3/8"	1/4"		
5404-06-06		3/8"	3/8"		
5404-08-04		1/2"	1/4"		
5404-08-06		1/2"	3/8"		
5404-08-08		1/2"	1/2"		
5404-12-06		3/4"	3/8"		
5404-12-08		3/4"	1/2"		
5404-12-12		3/4"	3/4"		
5404-16-08		1"	1/2"		
5404-16-12		1"	3/4"		
5404-16-16		1"	1"		
5404-20-16		1 1/4"	1"		
5404-20-20		1 1/4"	1 1/4"		
5404-24-16		1 1/2"	1"		
5404-24-20		1 1/2"	1 1/4"		
5404-24-24		1 1/2"	1 1/2"		
5404-32-32		2"	2"		



5500				NPT MALE - 90°	
Part No.	Price	NPT M	NPT M	Visual	
5500-02-02		1/8"	1/8"		
5500-04-04		1/4"	1/4"		
5500-06-06		3/8"	3/8"		
5500-08-08		1/2"	1/2"		
5500-12-12		3/4"	3/4"		
5500-16-16		1"	1"		
5500-20-20		1 1/4"	1 1/4"		
5500-24-24		1 1/2"	1 1/2"		
5500-32-32		2"	2"		



NPT ADAPTORS

1404

MALE NPT x FEMALE SWIVEL NPT STRAIGHT

Part No.	Price	NPT M	NPT F	Visual
1404-02-02		1/8"	1/8"	
1404-02-04		1/8"	1/4"	
1404-04-02		1/4"	1/8"	
1404-04-04		1/4"	1/4"	
1404-04-06		1/4"	3/8"	
1404-06-04		3/8"	1/4"	
1404-06-06		3/8"	3/8"	
1404-06-08		3/8"	1/2"	
1404-08-04		1/2"	1/4"	
1404-08-06		1/2"	3/8"	
1404-08-08		1/2"	1/2"	
1404-08-12		1/2"	3/4"	
1404-12-08		3/4"	1/2"	
1404-12-12		3/4"	3/4"	
1404-12-16		3/4"	1"	
1404-16-12		1"	3/4"	
1404-16-16		1"	1"	
1404-16-20		1"	1 1/4"	
1404-20-20		1 1/4"	1 1/4"	
1404-20-24		1 1/4"	1 1/2"	
1404-24-24		1 1/2"	1 1/2"	
1404-32-32		2"	2"	

1501

MALE NPT x FEMALE SWIVEL NPT 90°

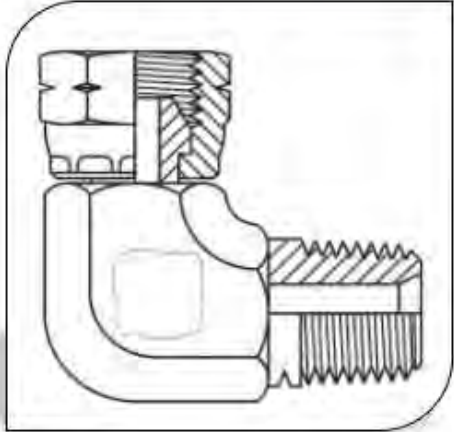
Part No.	Price	NPT M	NPT F	Visual
1501-02-02		1/8"	1/8"	
1501-02-04		1/8"	1/4"	
1501-04-02		1/4"	1/2"	
1501-04-04		1/4"	1/4"	
1501-04-06		1/4"	3/8"	
1501-06-04		3/8"	1/4"	
1501-06-06		3/8"	3/8"	
1501-06-08		3/8"	1/2"	
1501-08-06		1/2"	3/8"	
1501-08-08		1/2"	1/2"	
1501-08-12		1/2"	3/4"	
1501-12-08		3/4"	1/2"	
1501-12-12		3/4"	3/4"	
1501-12-16		3/4"	1"	
1501-16-12		1"	3/4"	
1501-16-16		1"	1"	
1501-16-20		1"	1 1/4"	
1501-20-16		1 1/4"	1"	
1501-20-20		1 1/4"	1 1/4"	
1501-24-24		1 1/2"	1 1/2"	
1501-32-32		2"	2"	



DOWTY WASHERS

DW

DOWTY WASHER - IMPERIAL

Part No.	Price	Size	Visual
DW-02		1/8"	
DW-04		1/4"	
DW-06		3/8"	
DW-08		1/2"	
DW-10		5/8"	
DW-12		3/4"	
DW-16		1"	
DW-20		1 1/4"	
DW-24		1 1/2"	
DW-32		2"	

DW_M

DOWTY WASHER - METRIC

Part No.	Price	Size (mm)	Visual
DW-06M		6	
DW-08M		8	
DW-10M		10	
DW-12M		12	
DW-14M		14	
DW-16M		16	
DW-18M		18	
DW-20M		20	
DW-22M		22	
DW-24M		24	
DW-26M		26	
DW-30M		30	
DW-36M		36	

BSP ADAPTORS

C40XS

JIC x BSP 90°

Part No.	Price	JIC	BSP	Visual
C40XS-04-02		7/16"	1/8"	
C40XS-04-04		7/16"	1/4"	
C40XS-04-06		7/16"	3/8"	
C40XS-06-04		9/16"	1/4"	
C40XS-06-06		9/16"	3/8"	
C40XS-06-08		9/16"	1/2"	
C40XS-08-06		3/4"	3/8"	
C40XS-08-08		3/4"	1/2"	
C40XS-08-12		3/4"	3/4"	
C40XS-10-08		7/8"	1/2"	
C40XS-10-12		7/8"	3/4"	
C40XS-12-08		1 1/16"	1/2"	
C40XS-12-12		1 1/16"	3/4"	
C40XS-12-16		1 1/16"	1"	
C40XS-16-12		1 5/16"	3/4"	
C40XS-16-16		1 5/16"	1"	
C40XS-20-20		1 5/8"	1 1/4"	
C40XS-24-24		1 7/8"	1 1/2"	

1404B

BSP MALE x BSP FEMALE SWIVEL

Part No.	Price	Size	Visual
1404B-06-06		3/8"	
1404B-08-08		1/2"	
1404B-12-12		3/4"	

5000B

BSP FEMALE SOCKET - STRAIGHT

Part No.	Price	Size	Visual
5000B-04-04		1/4"	
5000B-06-06		3/8"	
5000B-08-08		1/2"	
5000B-12-12		3/4"	
5000B-16-16		1"	

5605B

BSP FEMALE SOCKET - TEES

Part No.	Price	Size	Visual
5605B-02-02-02		1/8"	
5605B-04-04-04		1/4"	
5605B-06-06-06		3/8"	
5605B-08-08-08		1/2"	

BSP ADAPTORS

MCJB

JIC x BSP STRAIGHT

Part No.	Price	JIC	BSP	Visual
MCJB-04-02		7/16"	1/8"	
MCJB-04-04		7/16"	1/4"	
MCJB-04-06		7/16"	3/8"	
MCJB-04-08		7/16"	1/2"	
MCJB-05-04		1/2"	1/4"	
MCJB-06-04		9/16"	1/4"	
MCJB-06-06		9/16"	3/8"	
MCJB-06-08		9/16"	1/2"	
MCJB-06-10		9/16"	5/8"	
MCJB-06-12		9/16"	3/4"	
MCJB-08-04		3/4"	1/4"	
MCJB-08-06		3/4"	3/8"	
MCJB-08-08		3/4"	1/2"	
MCJB-08-10		3/4"	5/8"	
MCJB-08-12		3/4"	3/4"	
MCJB-08-16		3/4"	1"	
MCJB-10-06		7/8"	3/8"	
MCJB-10-08		7/8"	1/2"	
MCJB-10-10		7/8"	5/8"	
MCJB-10-12		7/8"	3/4"	
MCJB-12-08		1 1/16"	1/2"	
MCJB-12-10		1 1/16"	5/8"	
MCJB-12-12		1 1/16"	3/4"	
MCJB-12-16		1 1/16"	1"	
MCJB-12-20		1 1/16"	1 1/4"	
MCJB-16-12		1 5/16"	3/4"	
MCJB-16-16		1 5/16"	1"	
MCJB-16-20		1 5/16"	1 1/4"	
MCJB-16-24		1 5/16"	1 1/2"	
MCJB-20-16		1 5/8"	1"	
MCJB-20-20		1 5/8"	1 1/4"	
MCJB-20-24		1 5/8"	1 1/2"	
MCJB-24-20		1 7/8"	1 1/4"	
MCJB-24-24		1 7/8"	1 1/2"	
MCJB-32-32		2 1/2"	2"	



BHB

BSP BULKHEAD WITH LOCKNUT

Part No.	Price	Thread	Visual
BHB-04		1/4"	
BHB-06		3/8"	
BHB-08		1/2"	
BHB-10		5/8"	
BHB-12		3/4"	
BHB-16		1"	
BHB-20		1 1/4"	



BSPT ADAPTORS

HNBT

BSP x BSPT STRAIGHT

Part No.	Price	BSP	BSPT	Visual
HNBT-02-02		1/8"	1/8"	
HNBT-02-04		1/8"	1/4"	
HNBT-04-02		1/4"	1/8"	
HNBT-04-04		1/4"	1/4"	
HNBT-04-06		1/4"	3/8"	
HNBT-04-08		1/4"	1/2"	
HNBT-06-04		3/8"	1/4"	
HNBT-06-06		3/8"	3/8"	
HNBT-06-08		3/8"	1/2"	
HNBT-08-04		1/2"	1/4"	
HNBT-08-06		1/2"	3/8"	
HNBT-08-08		1/2"	1/2"	
HNBT-08-12		1/2"	3/4"	
HNBT-08-16		1/2"	1"	
HNBT-10-06		5/8"	3/8"	
HNBT-10-08		5/8"	1/2"	
HNBT-10-10		5/8"	5/8"	
HNBT-12-08		3/4"	1/2"	
HNBT-12-12		3/4"	3/4"	
HNBT-12-16		3/4"	1"	
HNBT-16-12		1"	3/4"	
HNBT-16-16		1"	1"	
HNBT-16-20		1"	1 1/4"	
HNBT-20-16		1 1/4"	1"	
HNBT-20-20		1 1/4"	1 1/4"	
HNBT-20-24		1 1/4"	1 1/2"	
HNBT-24-20		1 1/2"	1 1/4"	
HNBT-24-24		1 1/2"	1 1/2"	
HNBT-24-32		1 1/2"	2"	
HNBT-32-20		2"	1 1/4"	
HNBT-32-24		2"	1 1/2"	
HNBT-32-32		2"	2"	



304B

BSPP FEMALE SWIVEL CAP

Part No.	Price	BSP	Visual
304B-04		1/4"	
304B-06		3/8"	
304B-08		1/2"	
304B-12		3/4"	
304B-16		1"	

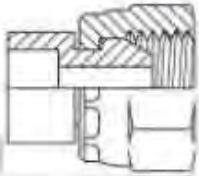

BSP & BSPT ADAPTORS

HNB

BSP x BSP ADAPTOR

Part No.	Price	BSP	BSP	Visual
HNB-02-02		1/8"	1/8"	
HNB-04-02		1/4"	1/8"	
HNB-04-04		1/4"	1/4"	
HNB-06-04		3/8"	1/4"	
HNB-06-06		3/8"	3/8"	
HNB-08-04		1/2"	1/4"	
HNB-08-06		1/2"	3/8"	
HNB-08-08		1/2"	1/2"	
HNB-10-08		5/8"	1/2"	
HNB-10-10		5/8"	5/8"	
HNB-12-04		3/4"	1/4"	
HNB-12-06		3/4"	3/8"	
HNB-12-08		3/4"	1/2"	
HNB-12-10		3/4"	5/8"	
HNB-12-12		3/4"	3/4"	
HNB-16-08		1"	1/2"	
HNB-16-12		1"	3/4"	
HNB-16-16		1"	1"	
HNB-20-08		1 1/4"	1/2"	
HNB-20-12		1 1/4"	3/4"	
HNB-20-16		1 1/4"	1"	
HNB-20-20		1 1/4"	1 1/4"	
HNB-24-16		1 1/2"	1"	
HNB-24-20		1 1/2"	1 1/4"	
HNB-24-24		1 1/2"	1 1/2"	
HNB-32-24		2"	1 1/2"	
HNB-32-32		2"	2"	



HNBTT

BSPT x BSPT ADAPTOR

Part No.	Price	BSPT	BSPT	Visual
HNBTT-04-04		1/4"	1/4"	
HNBTT-06-04		3/8"	1/4"	
HNBTT-06-06		3/8"	3/8"	
HNBTT-08-06		1/2"	3/8"	
HNBTT-08-08		1/2"	1/2"	
HNBTT-12-12		3/4"	3/4"	
HNBTT-16-16		1"	1"	



Adaptors Index -2

Male x Female Adaptors

STRAIGHT	BSP MALE x BSP FEMALE SWIVEL	1404B	Page 4
	NPT MALE x NPT FEMALE - STRAIGHT	1404	Page 6
	NPT MALE x NPT FEMALE	5405	Page 9
	JIC MALE x NPT FEMALE - STRAIGHT - FIXED	2405	Page 13
	NPT MALE x JIC FEMALE - STRAIGHT - SWIVEL	6505	Page 14
	JIC MALE x JIC FEMALE - STRAIGHT - SWIVEL	6504	Page 18
90°	NPT MALE x NPT FEMALE - 90° - SWIVEL	1501	Page 6
	NPT MALE x NPT FEMALE - 90° - FIXED ELBOW	5502	Page 9
	JIC MALE x NPT FEMALE - 90° - FIXED	2502	Page 13
	NPT MALE x JIC FEMALE - 90° - SWIVEL	6501	Page 14
	JIC MALE x JIC FEMALE - 90° - SWIVEL	6500	Page 22
	ORFS MALE x ORFS FEMALE - 90° - SWIVEL	FF6500	Page 20
45°	NPT MALE x NPT FEMALE - 45°	1503	Page 7
	JIC MALE x JIC FEMALE - 45° - SWIVEL	6502	Page 19
	ORFS MALE x ORFS FEMALE - 45° - SWIVEL	FF6502	Page 22
REDUCERS	NPT MALE/FEMALE REDUCING BUSH	5406	Page 10
	JIC MALE/FEMALE REDUCING BUSH	2406	Page 20
	ORFS MALE/FEMALE REDUCING BUSH	FF2406	Page 25
T - PIECES	NPT RUN 'T'	5602	Page 9
	NPT BRANCH 'T'	5604	Page 9
	JIC RUN 'T'	6602	Page 19
	JIC BRANCH 'T'	6600	Page 19
	ORFS RUN 'T'	FF6602	Page 23
	ORFS BRANCH 'T'	FF6600	Page 23

Other Adaptors

SOCKETS & FEM TO FEM ADAPT	BSP SOCKET - FEMALE - STRAIGHT	5000B	Page 4
	NPT SOCKET - STRAIGHT	5000	Page 8
	NPT SOCKET - 90°	5504	Page 8
	NPT SOCKET - 'T' PIECE	5605	Page 8
	NPT SOCKET - FEMALE CROSS	5652	Page 8
	BSP SOCKET - 'T' PIECE	5605B	Page 4
	JIC FEMALE SWIVEL x NPT FEMALE - STRAIGHT	6506	Page 14
NUTS, LOCKNUTS & CAPS	JIC CAP	304C	Page 19
	ORFS CAP	FF304C	Page 23
	BSPP FEMALE SWIVEL CAP	304B	Page 2
	JIC TUBE NUT (FLARE NUT)	318	Page 20
	JIC FERRULES	319	Page 20
	JIC LOCKNUT	0306	Page 19
DOWTY WASHERS	DOWTY WASHER - IMPERIAL	DW	Page 5
	DOWTY WASHER - METRIC	DW_M	Page 5

Adaptors Index -1

Male x Male Adaptors

STRAIGHT	BSP MALE x BSP MALE - STRAIGHT	HNB	Page 1
	BSPT MALE x BSPT MALE - STRAIGHT	HNBTT	Page 1
	BSP MALE x BSPT MALE - STRAIGHT	HNBT	Page 2
	JIC MALE x BSP MALE - STRAIGHT	MCJB	Page 3
	NPT MALE x NPT MALE - STRAIGHT	5404	Page 7
	JIC MALE x NPT MALE - STRAIGHT	2404	Page 11
	JIC MALE x JIC MALE - STRAIGHT	2403	Page 15
	JIC MALE x METRIC MALE - STRAIGHT	JM_MM	Page 16
	JIC MALE x SAE O' RING MALE - STRAIGHT	6400	Page 17
	ORFS MALE x SAE O' RING MALE - STRAIGHT	FF6400	Page 22
	ORFS MALE x ORFS MALE - STRAIGHT	FF2403	Page 23
	ORFS MALE x NPT MALE - STRAIGHT	FF2404	Page 24
	ORFS MALE x BSP MALE - STRAIGHT	MCFB	Page 25
90°	JIC MALE x BSP MALE - 90°	C40XS	Page 4
	NPT MALE x NPT MALE - 90°	5500	Page 7
	JIC MALE x NPT MALE - 90°	2501	Page 12
	JIC MALE x JIC MALE - 90°	2500	Page 15
	JIC MALE x SAE O' RING MALE - 90°	6801	Page 22
	ORFS MALE x NPT MALE - 90°	FF2501	Page 24
	ORFS MALE x SAE O' RING MALE - 90°	FF6801	Page 20
45°	ORFS MALE x NPT MALE - 90°	FF2502	Page 22
	ORFS MALE x BSP MALE - 90°	FFC40XS	Page 25
	JIC MALE x NPT MALE - 45°	2503	Page 13
BULKHEADS	JIC MALE x SAE O' RING - 45°	6802	Page 23
	ORFS MALE x SAE O' RING MALE - 45°	FF6802	Page 21
	BSP BULKHEAD WITH LOCKNUT - STRAIGHT	BHB	Page 3
	JIC BULKHEAD - STRAIGHT	2700	Page 19
	JIC BULKHEAD - 90°	2701	Page 19
T - PIECES	ORFS BULKHEAD - STRAIGHT	FF2700	Page 23
	ORFS BULKHEAD - 90°	FF2701	Page 23
	JIC/NPT BRANCH 'T'	2601	Page 14
	JIC/NPT RUN 'T'	2605	Page 14
	JIC MALE 'T'	2603	Page 19
	ORFS/SAE MALE BRANCH 'T'	FF6803	Page 23
	ORFS/SAE MALE RUN 'T'	FF6804	Page 24
PLUGS	JIC PLUG	2408	Page 21
	SAE PLUG	6408P	Page 19
	SAE PLUG - ALLEN KEY TYPE	6409	Page 21
	NPT PLUG	5406P	Page 21
	BSP PLUG	HPB	Page 21
	ORFS PLUG	FF2408	Page 25



African
Hose
Solutions

Section D | Adaptors



069 962 1589



010 065 387 2 / 3 / 4



Admin@AfricanHoseSolutions.co.za



Facebook.com/AfricanHoseSolutions

QUICK RELEASE COUPLERS

5010 & 5050

BALL TYPE MALE & FEMALE COUPLER - BSP

Part No.	Price	Size (inches)	Visual
MALE			
5010-02		1/4	
5010-03		3/8	
5010-04		1/2	
5010-05		3/4	
5010-06		1	
FEMALE			
5050-02		1/4	
5050-03		3/8	
5050-04		1/2	
5050-05		3/4	
5050-06		1	

5010P & 5050P

PIN TYPE MALE & FEMALE COUPLER - BSP

Part No.	Price	Size (inches)	Visual
MALE			
5010-02P		1/4	
5010-03P		3/8	
5010-04P		1/2	
5010-05P		3/4	
5010-06P		1	
5010-07P		1 1/4	
FEMALE			
5050-02P		1/4	
5050-03P		3/8	
5050-04P		1/2	
5050-05P		3/4	
5050-06P		1	
5050-07P		1 1/4	

QCPM

PLASTIC PROTECTION FOR QRC

MALE			Visual	FEMALE		
Part No.	Price	Size		Part No.	Price	Size
	Each	Thread			Each	Thread
QCPM-02		7/16		QCPM-02		7/16
QCPM-03		1/2		QCPM-03		1/2
QCPM-04		9/16		QCPM-04		9/16
QCPM-05		3/4		QCPM-05		3/4
QCPM-06		7/8		QCPM-06		7/8

QUICK RELEASE COUPLERS

3010 & 3050

SCREW IN ENERPAC TYPE MALE & FEMALE COUPLER - NPT

Part No.	Price	Size (inches)	Visual
MALE			
3010-02		1/4	
3010-03		3/8	
FEMALE			
3050-02		1/4	
3050-03		3/8	

4010 & 4050

BALL TYPE MALE & FEMALE COUPLER - NPT

Part No.	Price	Size (inches)	Visual
MALE			
4010-02		1/4	
4010-03		3/8	
4010-04		1/2	
4010-05		3/4	
4010-06		1	
FEMALE			
4050-02		1/4	
4050-03		3/8	
4050-04		1/2	
4050-05		3/4	
4050-06		1	

4010F & 4050F

FLAT FACED MALE & FEMALE COUPLER - NPT

Part No.	Price	Size (inches)	Visual
MALE			
4010-04F		1/2	
4010-06F		3/4	
FEMALE			
4050-04F		1/2	
4050-06F		3/4	

4010P & 4050P

PIN TYPE MALE & FEMALE COUPLER - NPT

Part No.	Price	Size (inches)	Visual
MALE			
4010-03P		3/8	
4010-04P		1/2	
4010-05P		3/4	
4010-06P		1	
FEMALE			
4050-03P		3/8	
4050-04P		1/2	
4050-05P		3/4	
4050-06P		1	

Index

Quick Release Couplers

Screw-In Enerpac Type Male Coupler - NPT	3010	Page 1
Screw-In Enerpac Type Female Coupler - NPT	3050	Page 1
Ball Type Male Coupler - NPT	4010	Page 1
Ball Type Female Coupler - NPT	4050	Page 1
Flat Faced Male Coupler - NPT	4010F	Page 1
Flat Faced Female Coupler - NPT	4050F	Page 1
Pin Type Male Coupler - NPT	4010P	Page 1
Pin Type Female Coupler - NPT	4050P	Page 1
Ball Type Male Coupler - BSP	5010	Page 2
Ball Type Female Coupler - BSP	5050	Page 2
Pin Type Male Coupler - BSP	5010P	Page 2
Pin Type Female Coupler - BSP	5050P	Page 2
Pin Type Male Coupler - BSP	5010P	Page 2



African Hose Solutions

Section C

Quick Release Couplers



069 962 1589



010 065 387 2 / 3 / 4



Admin@AfricanHoseSolutions.co.za



[Facebook.com/AfricanHoseSolutions](https://www.facebook.com/AfricanHoseSolutions)

PLASTIC PROTECTION PLUGS - MALES

TMG

BSP MALE PLUGS

TO SUIT BSP FEMALE FITTINGS

Part No.	Price Each	Size		Visual
		Thread	Dash	
TMG-02		1/8	-2	
TMG-04		1/4	-4	
TMG-06		3/8	-6	
TMG-08		1/2	-8	
TMG-10		5/8	-10	
TMG-12		3/4	-12	
TMG-16		1	-16	
TMG-20		1 1/4	-20	
TMG-24		1 1/2	-24	
TMG-32		2	-32	

TFU

JIC/UNF MALE PLUGS

TO SUIT FEMALE FITTINGS

Part No.	Price Each	Size		Visual
		Thread	Dash	
TMU-04		7/16	-4	
TMU-05		1/2	-5	
TMU-06		9/16	-6	
TMU-08		3/4	-8	
TMU-10		7/8	-10	
TMU-12		1 1/16	-12	
TMU-16		1 5/16	-16	
TMU-20		1 5/8	-20	
TMU-24		1 7/8	-24	
TMU-32		2 1/2	-32	
TMM-22X1.5		22X1.5		

QCPM

PLASTIC PROTECTION FOR QRC

MALE

FEMALE

Part No.	Price Each	Size		Visual	Part No.	Price Each	Size	
		Thread					Thread	
QCPM-02		7/16			QCPM-02		7/16	
QCPM-03		1/2			QCPM-03		1/2	
QCPM-04		9/16			QCPM-04		9/16	
QCPM-05		3/4			QCPM-05		3/4	
QCPM-06		7/8			QCPM-06		7/8	

With a light pressure and a half turn, it fits perfectly. To remove it, you don't need any tools. You just unscrew it and the thread stays clean and undamaged



PLASTIC PROTECTION PLUGS & FLANGE PLASTIC CAPS

TFG

BSP FEMALE PLUGS

TO SUIT BSP MALE FITTINGS

Part No.	Price	Size		Visual
	Each	Thread	Dash	
TFG-02		1/8	-2	
TFG-04		1/4	-4	
TFG-06		3/8	-6	
TFG-08		1/2	-8	
TFG-10		5/8	-10	
TFG-12		3/4	-12	
TFG-16		1	-16	
TFG-20		1 1/4	-20	
TFG-24		1 1/2	-24	
TFG-32		2	-32	

TFU

JIC/UNF FEMALE PLUGS

TO SUIT MALE FITTINGS

Part No.	Price	Size		Visual
	Each	Thread	Dash	
TFU-04		7/16	-4	
TFU-05		1/2	-5	
TFU-06		9/16	-6	
TFU-08		3/4	-8	
TFU-10		7/8	-10	
TFU-12		1 1/16	-12	
TFU-16		1 5/16	-16	
TFU-20		1 5/8	-20	
TFU-24		1 7/8	-24	
TFU-32		2 1/2	-32	

FL3000 / FL6000

FLANGE PLASTIC CAPS - 3000 & 6000 SERIES

TO SUIT FLANGES

Part No.	Price	Size		Visual	
	Each	Thread	Dash		
3000 SERIES					
FL3000-08		1/2	-8		
FL3000-12		3/4	-12		
FL3000-16		1	-16		
FL3000-20		1 1/4	-20		
FL3000-24		1 1/2	-24		
FL3000-32		2	-32		
6000 SERIES					
FL6000-12		3/4	-12		
FL6000-16		1	-16		
FL6000-20		1 1/4	-20		
FL6000-24		1 1/2	-24		
FL6000-32		2	-32		

BRAKE FITTINGS & BRAKE HOSE

EF				ONE PIECE BRAKE FITTINGS & BRAKE HOSE			
Part No.	Price	COHNENS	Description	Part No.	Price	COHNENS	Description
EF012			11/16 X16tpi MALE	EF192			12 x 1mm MALE
EF020		6399-0284	7/16 -20 UNF FEMALE STD	EF196			3/8 UN MALE 1/2 -20 MALE
EF023		6399-0314	3/8 -20 UNF MALE STUD	EF202		6399-0291	M10x1 LEFT HAND MALE
EF024		6399-0288	3/8 -20 NS FEMALE STD	EF205		6399-0305	M10x1 MALE STUD
EF027			7/16 x 20UNF MALE	EF210			12x1.5 MALE LONG
EF029			SPECIAL BANJO	EF229			M10 x 1 LONG STEM MALE
EF030		6399-0276	3/8 -24 UNF MALE BUBBLE	EF234			10 x 1mm MALE
EF031		6399-0281	3/8 -24 UNF MALE STD	EF236			M10 x 1 MALE
EF035			3/8 -24 UNF MALE	EF247		6399-0304	M10x1 FEMALE STANDARD
EF036		6399-0311	3/8 -24 UNF FEMALE BUBBLE	EF264		6399-0290	1/2-20 UNF MALE STD
EF037			7/16 x 20 unf MALE	EF268		6399-0272	M12x1 FEMALE STANDARD
EF038		6399-0201	3/8 -24 UNF FEMALE BUBBLE	EF286			1.2 -20 UNF MALE
EF040		6399-0264	M10 x1 MALE BUBBLE LONG	EF287			1/2 -20 UNF MALE
EF046			3/8 x 24 unf MALE	EF304			1/8" ANGLED BANJO
EF050		6399-0275	M12x1 MALE STANDARD	EF312			M12 x 1 FLAT MALE
EF051			12x1 FEMALE	EF348			12 x 1mm MALE
EF052		6399-0274	M10x1 MALE STANDARD	EF338			3/16" FEM THREAD SWIVEL
EF053		6399-0270	M,10x1 FEMALE BUBBLE	EF359			
EF054			10x1.25 SHORT MALE	EF362			HOSE JOINER
EF056			14 x 1.5mm MALE	EF362			SPECIAL BANJO
EF058			12 x 1mm MALE	EF379			SPECIAL BANJO 25
EF067			7/16 x 20 UNF FEMALE	EF382			10x1 KNURLED (non std)
EF076			3/8 x 24 UNF FEMALE	EF383			10x1 H/END with innercon.
EF101			10x1.25 FEMALE	EF386			10x1 H/END with innercon.
EF104		6399-289	7/16 -20 UNF MALE STD	EF389			SPECIAL BANJO
EF110			3/8 -24 UNF MALE	EF396			10 x 1mm FEMALE
EF128			1/8" ANGLED BANJO	EF401			Special BANJO
EF133			7/16 -20 LONG MALE	EF402			1/8" HOSE TO HOSE CON.
EF135			71/6 x 24 - 5/8 x 18 unf ML/FEM	EF403			10 x 1mm FEMALE
EF138		6399-0265	M10x1 FEMALE STANDARD	EF409			7/16x24 -5/8 x 18UNF
EF139				EF413			SPECIAL
EF140		6399-0267	M10 x 1 MALE STANDARD	EF424		6381-0403	M10 BANJO
EF148			3/8 -24 UNF FEMALE	EF430		6399-0292	M10 x 1 FEMALE BUBBLE
EF151			10 x 1.25mm FEMALE	EF429		6381-0263	M10 x 1 FEMALE
EF152			10 x 1.25mm MALE	EF436			SWIVEL END FITTING
EF156			10 x1 MALE	EF438			10 x1 MALE
EF159			12 x 1.25 - 18 x 1.5 MALE/FEM	EF450			
EF160			12x1.25 SHORT MALE	EF455			
EF170			12 x 1.25mm FEMALE	EF458			7/16x24 unf SWIVEL FITTING
EF171			12 x 1.25 MALE	EF459			RECTANGULAR BANJO
EF172			SPECIAL BANJO	EF483			
EF179			11/16 X16tpi MALE	EF708			
EF180		6399-0270	M10x1 MALE LONG STUD	SL599			HOSE SLEEVE COVER
EF183		6399-0286	M10x1 FEMALE STANDARD	SP709			PLASTIC STRIPING
EF185			10x1.25 SHORT MALE STUD	6301-0300		6301-0300	SLEEVES
EF186				435-0300		0435-0300	1/8" BRAKE HOSE (per mt)
				6301-0100		6301-0100	1/8" BLANK TAIL (lifesaver)

PUSHLOK FITTINGS

30682

BRASS PUSHLOK FITTINGS - JIC FEMALE

Part No.	Price	JIC	Hose	Visual
30682-04-04B		7/16"	1/4"	
30682-05-04B		1/2"	1/4"	
30682-06-04B		3/8"	1/4"	
30682-06-06B		9/16"	3/8"	
30682-08-06B		3/4"	3/8"	
30682-08-08B		3/4"	1/2"	
30682-08-10B		1/2"	5/8"	
30682-10-08B		7/8"	5/8"	
30682-10-10B		7/8"	5/8"	
30682-12-12B		1 1/16"	3/4"	
30882-06-06B		5/8"-18 SAE	3/8"	

30182

BRASS PUSHLOK FITTINGS - NPT MALE

Part No.	Price	NPT	Hose	Visual
30182-02-04B		1/8"	1/4"	
30182-04-04B		1/4"	1/4"	
30182-04-06B		1/4"	3/8"	
30182-06-04B		3/8"	1/4"	
30182-06-06B		3/8"	3/8"	
30182-06-08B		3/8"	1/2"	
30182-08-06B		1/2"	3/8"	
30182-08-08B		1/2"	1/2"	
30182-12-08B		3/4"	1/2"	
30182-12-12B		3/4"	3/4"	

39282

BRASS PUSHLOK FITTINGS - BSP FEMALE

Part No.	Price	BSP	Hose	Visual
39282-04-04		1/4"	1/4"	
39282-06-06		3/8"	3/8"	
39282-08-08		1/2"	1/2"	
39282-10-10		5/8"	5/8"	
39282-12-12		3/4"	3/4"	
39282-16-16		1"	1"	

38282

BRASS PUSHLOK FITTINGS - HOSE JOINERS

Part No.	Price	BSP	Hose	Visual
38282-04-04		1/4"	1/4"	
38282-06-06		3/8"	3/8"	
38282-08-08		1/2"	1/2"	

HOSE FITTINGS - RE-USABLE & FLANGE ADAPTORS

R_J90

RE-USABLE HOSE FITTING - JIC FEMALE 90°

Part No.	Price	Thread	Dash	Hose	Visual
R07J90S04		7/16"	- 4	1/4"	
R08J90S04		1/2"	- 5	1/4"	
R09J90S04		9/16"	- 6	1/4"	
R09J90S06		9/16"	- 6	3/8"	
R12J90S06		3/4"	- 8	3/8"	
R12J90S08		3/4"	- 8	1/2"	
R14J90S08		7/8"	- 10	1/2"	
R17J90S12		1 1/16"	- 12	3/4"	
R21J90S16		1 5/16"	- 16	1"	

R_JM

RE-USABLE HOSE FITTING - JIC MALE

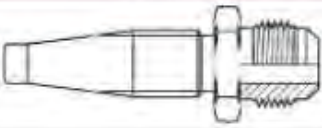
Part No.	Price	Thread	Dash	Hose	Visual
R08JM04		1/2"	- 5	1/4"	
R09JM04		9/16"	- 6	1/4"	
R12JM06		3/4"	- 8	3/8"	
R17JM12		1 1/16"	- 12	3/4"	

15T3

JIC FLANGE ADAPTOR - 3000 SERIES - STRAIGHT

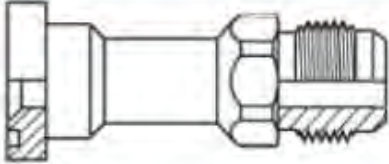
Part No.	Price	Flange	FL. O.D.	JIC	Visual
15T3-12-12		3/4"	38.10 mm	3/4"	
15T3-16-12		1"	44.50 mm	3/4"	
15T3-16-16		1"	44.50 mm	1"	
15T3-20-16		1 1/4"	50.80 mm	1"	
15T3-20-20		1 1/4"	50.80 mm	1 1/4"	
15T3-24-20		1 1/2"	60.30 mm	1 1/4"	

*6000 SERIES AVAILABLE ON REQUEST

19T3

JIC FLANGE ADAPTOR - 3000 SERIES - 90°

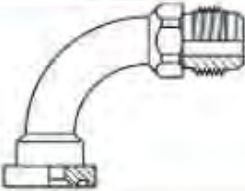
Part No.	Price	Flange	FL. O.D.	JIC	Visual
19T3-12-12		3/4"	38.10 mm	3/4"	
19T3-16-12		1"	44.50 mm	3/4"	
19T3-16-16		1"	44.50 mm	1"	
19T3-20-16		1 1/4"	50.80 mm	1"	
19T3-20-20		1 1/4"	50.80 mm	1 1/4"	
19T3-24-20		1 1/2"	60.30 mm	1 1/4"	

*6000 SERIES AVAILABLE ON REQUEST

17T3

JIC FLANGE ADAPTOR - 3000 SERIES - 45°

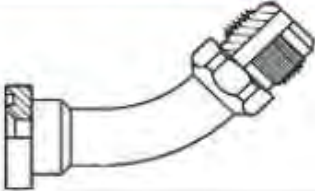
Part No.	Price	Flange	FL. O.D.	JIC	Visual
17T3-12-12		3/4"	38.10 mm	3/4"	
17T3-16-12		1"	44.50 mm	3/4"	
17T3-16-16		1"	44.50 mm	1"	
17T3-20-16		1 1/4"	50.80 mm	1"	
17T3-20-20		1 1/4"	50.80 mm	1 1/4"	
17T3-24-20		1 1/2"	60.30 mm	1 1/4"	

*6000 SERIES AVAILABLE ON REQUEST

HOSE FITTINGS - RE-USABLE (FOR 2SN / R2AT HOSE)

R2T

RE-USABLE HOSE FITTINGS - SLEEVES

Part No.	Price	Size	Dash	Hose	Visual
R2T-04		1/4"	- 4	1/4"	
R2T-06		3/8"	- 6	3/8"	
R2T-08		1/2"	- 8	1/2"	
R2T-12		3/4"	- 12	3/4"	
R2T-16		1"	- 16	1"	

R_BF

RE-USABLE HOSE FITTING - BSP FEMALE STRAIGHT

Part No.	Price	Thread	Dash	Hose	Visual
R04BF04		1/4"	- 4	1/4"	
R06BF06		3/8"	- 6	3/8"	
R08BF08		1/2"	- 8	1/2"	
R12BF12		3/4"	- 12	3/4"	
R16BF16		1"	- 16	1"	

R_B90

RE-USABLE HOSE FITTING - BSP FEMALE 90°

Part No.	Price	Thread	Dash	Hose	Visual
R04B90S04		1/4"	- 4	1/4"	
R06B90S06		3/8"	- 6	3/8"	
R08B90S08		1/2"	- 8	1/2"	
R12B90S12		3/4"	- 12	3/4"	
R16B90S16		1"	- 16	1"	

R_NM

RE-USABLE HOSE FITTING - NPT MALE

Part No.	Price	Thread	Dash	Hose	Visual
R04NM04		1/4"	- 4	1/4"	
R06NM06		3/8"	- 6	3/8"	
R08NM08		1/2"	- 8	1/2"	
R12NM12		3/4"	- 12	3/4"	
R16NM16		1"	- 16	1"	

R_JF

RE-USABLE HOSE FITTING - JIC FEMALE STRAIGHT

Part No.	Price	Thread	Dash	Hose	Visual
R07JF04		7/16"	- 4	1/4"	
R08JF04		1.2"	- 5	1/4"	
R09JF04		9/16"	- 6	1/4"	
R09JF06		9/16"	- 6	3/8"	
R12JF06		3/4"	- 8	3/8"	
R12JF08		3/4"	- 8	1/2"	
R14JF08		7/8"	- 10	1/2"	
R17JF12		1 1/16"	- 12	3/4"	
R21JF16		1 5/16"	- 16	1"	

HOSE FITTINGS - INTERLOCK

ILLORF

INTERLOCK HOSE END - ORFS - FEMALE - STRAIGHT

Part No.	Price	Thread	Hose	Visual
IL12LORF12		1 3/16" -12	1 1/4"	
IL16LORF16		1 7/16" -12	1 1/2"	
IL20LORF20		1 11/16" -12	2"	

ILLORF90

INTERLOCK HOSE END - ORFS - FEMALE - 90°

Part No.	Price	Thread	Hose	Visual
IL12LORF90S12		1 3/16" -12	1 1/4"	
IL16LORF90S16		1 7/16" -12	1 1/2"	
IL20LORF90S20		1 11/16" -12	2"	

ILMSF

INTERLOCK HOSE END - METRIC - STRAIGHT

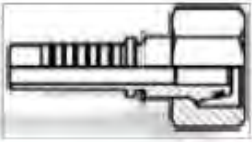
Part No.	Price	Thread	Pipe Size	Hose	Visual
IL36MSF25-12		36x2	25S	3/4"	
IL42MSF30-16		42x2	30S	1"	
IL52MSF38-20		52x2	38S	1 1/4"	

ILMSF90

INTERLOCK HOSE END - METRIC - 90°

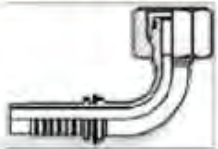
Part No.	Price	Thread	Pipe Size	Hose	Visual
IL36MSF90-2512		36x2	25S	3/4"	
IL36MSF90-2516		36x2	25S	1"	
IL42MSF90-3016		42x2	30S	1"	
IL52MSF90-3820		52x2	38S	1 1/4"	

ILMSF45

INTERLOCK HOSE END - METRIC - 45°

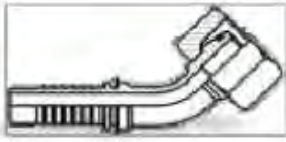
Part No.	Price	Thread	Pipe Size	Hose	Visual
IL36MSF45-2512		36x2	25S	3/4"	
IL42MSF45-3016		42x2	30S	1"	
IL52MSF45-3820		52x2	38S	1 1/4"	

HOSE FITTINGS - INTERLOCK

IL J90

INTERLOCK HOSE END - JIC FEMALE 90°

Part No.	Price	Thread	Dash	Hose	Visual
IL17J90S12		1 1/16"	- 12	3/4"	
IL21J90S16		1 5/16"	- 16	1"	
IL26J90S20		1 5/8"	- 20	1 1/4"	
IL30J90S24		1 7/8"	- 24	1 1/2"	
IL40J90S32		2 1/2"	- 32	2"	

IL J45

INTERLOCK HOSE END - JIC FEMALE 45°

Part No.	Price	Thread	Dash	Hose	Visual
IL17J45S12		1 1/16"	- 12	3/4"	
IL21J45S16		1 5/16"	- 16	1"	
IL26J45S20		1 5/8"	- 20	1 1/4"	
IL30J45S24		1 7/8"	- 24	1 1/2"	
IL40J45S32		2 1/2"	- 32	2"	

ILBF

INTERLOCK HOSE END - BSP FEMALE - STRAIGHT

Part No.	Price	Thread	Dash	Hose	Visual
IL12BF12		3/4"	-12	3/4"	
IL16BF16		1"	-16	1"	
IL20BF20		1 1/4"	-20	1 1/4"	
IL24BF24		1 1/2"	-24	1 1/2"	

ILB90

INTERLOCK HOSE END - BSP FEMALE - 90°

Part No.	Price	Thread	Dash	Hose	Visual
IL16B90S16		1"	-16	1"	
IL20B90S20		1 1/4"	-20	1 1/4"	

ILNM

INTERLOCK HOSE END - NPT MALE - STRAIGHT

Part No.	Price	Thread	Dash	Hose	Visual
IL20NM20		1 1/4"	-20	1 1/4"	
IL24NM24		1 1/2"	-24	1 1/2"	
IL32NM32		2"	-32	2"	

HOSE FITTINGS - INTERLOCK

ILSFH - 6000

INTERLOCK 6000 SERIES SOLID FLANGE - STRAIGHT

Part No.	Price	Flange	Flange O.D	Hose	Visual
IL12SFH-6-12		3/4"	41.30 mm	3/4"	
IL16SFH-6-12		1"	47.60 mm	3/4"	
IL12SFH-6-16		3/4"	41.30 mm	1"	
IL16SFH-6-16		1"	47.60 mm	1"	
IL20SFH-6-16		1 1/4"	54.00 mm	1"	
IL20SFH-6-20		1 1/4"	54.00 mm	1 1/4"	
IL24SFH-6-20		1 1/2"	63.50 mm	1 1/4"	
IL24SFH-6-24		1 1/2"	63.50 mm	1 1/2"	
IL32SFH-6-32		2"	79.40 mm	2"	

ILSFH90 - 6000

INTERLOCK 6000 SERIES SOLID FLANGE - 90°

Part No.	Price	Flange	Flange O.D	Hose	Visual
IL12SFH90-6-12		3/4"	41.30 mm	3/4"	
IL16SFH90-6-12		1"	47.60 mm	3/4"	
IL12SFH90-6-16		3/4"	41.30 mm	1"	
IL16SFH90-6-16		1"	47.60 mm	1"	
IL20SFH90-6-16		1 1/4"	54.00 mm	1"	
IL20SFH90-6-20		1 1/4"	54.00 mm	1 1/4"	
IL24SFH90-6-20		1 1/2"	63.50 mm	1 1/4"	
IL24SFH90-6-24		1 1/2"	63.50 mm	1 1/2"	
IL32SFH90-6-32		2"	79.40 mm	2"	

ILSFH45 - 6000

INTERLOCK 6000 SERIES SOLID FLANGE - 45°

Part No.	Price	Flange	Flange O.D	Hose	Visual
IL12SFH45-6-12		3/4"	41.30 mm	3/4"	
IL16SFH45-6-12		1"	47.60 mm	3/4"	
IL16SFH45-6-16		1"	47.60 mm	1"	
IL20SFH45-6-16		1 1/4"	54.00 mm	1"	
IL20SFH45-6-20		1 1/4"	54.00 mm	1 1/4"	
IL24SFH45-6-20		1 1/2"	63.50 mm	1 1/4"	
IL24SFH45-6-24		1 1/2"	63.50 mm	1 1/2"	
IL32SFH45-6-32		2"	79.40 mm	2"	

IL_JF

INTERLOCK HOSE END - JIC FEMALE STRAIGHT

Part No.	Price	Thread	Dash	Hose	Visual
IL17JF12		1 1/16"	- 12	3/4"	
IL21JF16		1 5/16"	- 16	1"	
IL26JF20		1 5/8"	- 20	1 1/4"	
IL30JF24		1 7/8"	- 24	1 1/2"	
IL40JF32		2 1/2"	- 32	2"	

HOSE FITTINGS - METRIC & INTERLOCK

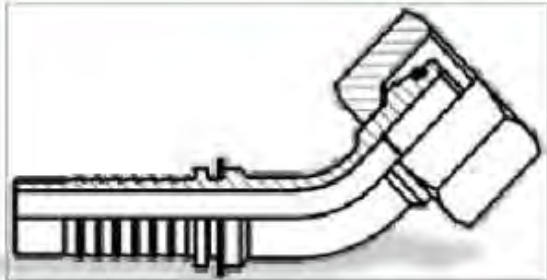
X_MSF 45 (H)		METRIC SWAGE FITTINGS - HEAVY SERIES - 45° FEMALE			
Part No.	Price	Thread	Pipe MM	Hose	Visual
X16MSF45S-0804		16 x 1.5	8S	1/4	
X18MSF45S-1004		18 x 1.5	10S	1/4	
X20MSF45S-1206		20 x 1.5	12S	3/8	
X22MSF45S-1406		22 x 1.5	14S	3/8	
X24MSF45S-1608		24 x 1.5	16S	1/2	
X30MSF45S-2010		30 x 2	20S	5/8	
X30MSF45S-2012		30 x 2	20S	3/4	
X36MSF45S-2512		36 x 2	25S	3/4	
X36MSF45S-2516		36 x 2	25S	1	
X42MSF45S-3016		42 x 2	30S	1	
X52MSF45S-3820		52 x 2	38S	1 1/4	

ILSFH - 3000		INTERLOCK 3000 SERIES SOLID FLANGE - STRAIGHT			
Part No.	Price	Flange	Flange O.D	Hose	Visual
IL12SFH-3-12		3/4"	38.10 mm	3/4"	
IL12SFH-3-16		3/4"	38.10 mm	1"	
IL16SFH-3-12		1"	44.50 mm	3/4"	
IL16SFH-3-16		1"	44.50 mm	1"	
IL20SFH-3-16		1 1/4"	50.80 mm	1"	
IL20SFH-3-20		1 1/4"	50.80 mm	1 1/4"	
IL24SFH-3-20		1 1/2"	60.30 mm	1 1/4"	
IL24SFH-3-24		1 1/2"	60.30 mm	1 1/2"	
IL32SFH-3-32		2"	71.40 mm	2"	

ILSFH90 - 3000		INTERLOCK 3000 SERIES SOLID FLANGE - 90°			
Part No.	Price	Flange	Flange O.D	Hose	Visual
IL12SFH90-3-12		3/4"	38.10 mm	3/4"	
IL12SFH90-3-16		3/4"	38.10 mm	1"	
IL16SFH90-3-12		1"	44.50 mm	3/4"	
IL16SFH90-3-16		1"	44.50 mm	1"	
IL20SFH90-3-16		1 1/4"	50.80 mm	1"	
IL20SFH90-3-20		1 1/4"	50.80 mm	1 1/4"	
IL24SFH90-3-20		1 1/2"	60.30 mm	1 1/4"	
IL24SFH90-3-24		1 1/2"	60.30 mm	1 1/2"	
IL32SFH90-3-32		2"	71.40 mm	2"	

ILSFH45 - 3000		INTERLOCK 3000 SERIES SOLID FLANGE - 45°			
Part No.	Price	Flange	Flange O.D	Hose	Visual
IL12SFH45-3-12		3/4"	38.10 mm	3/4"	
IL12SFH45-3-16		3/4"	38.10 mm	1"	
IL16SFH45-3-12		1"	44.50 mm	3/4"	
IL16SFH45-3-16		1"	44.50 mm	1"	
IL20SFH45-3-16		1 1/4"	50.80 mm	1"	
IL20SFH45-3-20		1 1/4"	50.80 mm	1 1/4"	
IL24SFH45-3-20		1 1/2"	60.30 mm	1 1/4"	
IL24SFH45-3-24		1 1/2"	60.30 mm	1 1/2"	
IL32SFH45-3-24		2"	71.40 mm	1 1/2"	
IL32SFH45-3-32		2"	71.40 mm	2"	

HOSE FITTINGS - METRIC

X_MSF 90 (L)

METRIC SWAGE FITTINGS - LIGHT SERIES - 90° FEMALE

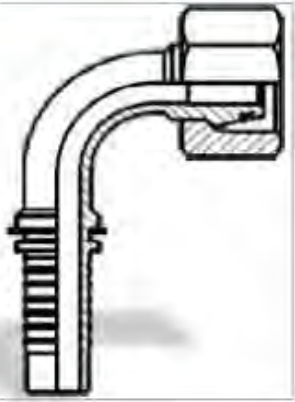
Part No.	Price	Thread	Pipe MM	Hose	Visual
X12MSF90S-0604		12 x 1.5	6L	1/4	
X14MSF90S-0804		14 x 1.5	8L	1/4	
X16MSF90S-1004		16 x 1.5	10L	1/4	
X16MSF90S-1005		16 x 1.5	10L	5/16	
X16MSF90S-1006		16 x 1.5	10L	3/8	
X18MSF90S-1206		18 x 1.5	12L	3/8	
X22MSF90S-1508		22 x 1.5	15L	1/2	
X26MSF90S-1808		26 x 1.5	18L	1/2	
X26MSF90S-1810		26 x 1.5	18L	5/8	
X30MSF90S-2212		30 x 2	22L	3/4	
X36MSF90S-2816		36 x 2	28L	1	
X45MSF90S-3520		45 x 2	35L	1 1/4	
X52MSF90S-4224		52 x 2	42L	1 1/2	

X_MSF 90 (H)

METRIC SWAGE FITTINGS - HEAVY SERIES - 90° FEMALE

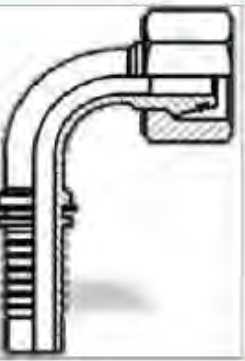
Part No.	Price	Thread	Pipe MM	Hose	Visual
X16MSF90S-0804		16 x 1.5	8S	1/4	
X18MSF90S-1004		18 x 1.5	10S	1/4	
X20MSF90S-1206		20 x 1.5	12S	3/8	
X22MSF90S-1406		22 x 1.5	14S	3/8	
X24MSF90S-1608		24 x 1.5	16S	1/2	
X30MSF90S-2010		30 x 2	20S	5/8	
X30MSF90S-2012		30 x 2	20S	3/4	
X36MSF90S-2512		36 x 2	25S	3/4	
X36MSF90S-2516		36 x 2	25S	1	
X42MSF90S-3016		42 x 2	30S	1	
X52MSF90S-3820		52 x 2	38S	1 1/4	

X_MSF 45 (L)

METRIC SWAGE FITTINGS - LIGHT SERIES - 45° FEMALE

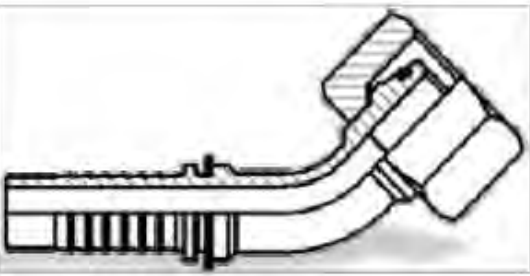
Part No.	Price	Thread	Pipe MM	Hose	Visual
X12MSF45S-0604		12 x 1.5	6L	1/4	
X14MSF45S-0804		14 x 1.5	8L	1/4	
X16MSF45S-1004		16 x 1.5	10L	1/4	
X16MSF45S-1006		16 x 1.5	10L	3/8	
X18MSF45S-1206		18 x 1.5	12L	3/8	
X22MSF45S-1508		22 x 1.5	15L	1/2	
X26MSF45S-1808		26 x 1.5	18L	1/2	
X26MSF45S-1810		26 x 1.5	18L	5/8	
X30MSF45S-2212		30 x 2	22L	3/4	
X36MSF45S-2816		36 x 2	28L	1	
X45MSF45S-3520		45 x 2	35L	1 1/4	
X52MSF45S-4224		52 x 2	42L	1 1/2	

HOSE FITTINGS - METRIC

X_ME (H)		METRIC SWAGE FITTINGS - HEAVY SERIES - STRAIGHT MALE				Visual
Part No.	Price	Thread	Pipe MM	Hose		
X16ME08-04		16 x 1.5	8S	1/4		
X18ME10-04		18 x 1.5	10S	1/4		
X18ME10-06		18 x 1.5	10S	3/8		
X20ME12-05		20 x 1.5	12S	5/16		
X20ME12-06		20 x 1.5	12S	3/8		
X22ME14-06		22 x 1.5	14S	3/8		
X24ME16-08		24 x 1.5	16S	1/2		
X30ME20-10		30 x 2	20S	5/8		
X30ME20-12		30 x 2	20S	3/4		
X36ME25-12		36 x 2	25S	3/4		
X36ME25-16		36 x 2	25S	1		
X42ME30-16		42 x 2	30S	1		
X52ME38-20		52 x 2	38S	1 1/4		

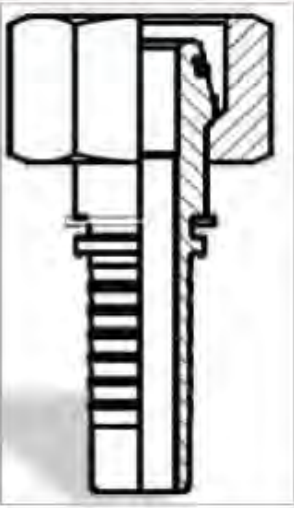
X_MSF (L)		METRIC SWAGE FITTINGS - LIGHT SERIES - STRAIGHT FEMALE				Visual
Part No.	Price	Thread	Pipe MM	Hose		
X12MSF06-04		12 x 1.5	6L	1/4		
X14MSF06-04		14 x 1.5	6L	1/4		
X14MSF08-04		14 x 1.5	8L	1/4		
X16MSF10-04		16 x 1.5	10L	1/4		
X16MSF10-05		16 x 1.5	10L	5/16		
X16MSF10-06		16 x 1.5	10L	3/8		
X18MSF12-05		18 x 1.5	12L	5/16		
X18MSF12-06P		18 x 1.5	12L	3/8		
X18MSF12-06		18 x 1.5	12L	3/8		
X22MSF15-06		22 x 1.5	15L	3/8		
X22MSF15-08		22 x 1.5	15L	1/2		
X26MSF18-08		26 x 1.5	18L	1/2		
X26MSF18-10		26 x 1.5	18L	5/8		
X30MSF22-12		30 x 2	22L	3/4		
X36MSF28-16		36 x 2	28L	1		
X45MSF35-20		45 x 2	35L	1 1/4		
X52MSF42-24		52 x 2	42L	1 1/2		

X_MSF (H)		METRIC SWAGE FITTINGS - HEAVY SERIES - STRAIGHT FEMALE				Visual
Part No.	Price	Thread	Pipe MM	Hose		
X16MSF08-04		16 x 1.5	8S	1/4		
X18MSF10-04		18 x 1.5	10S	1/4		
X20MSF12-06		20 x 1.5	12S	3/8		
X22MSF14-06		22 x 1.5	14S	3/8		
X24MSF16-08		24 x 1.5	16S	1/2		
X30MSF20-10		30 x 2	20S	5/8		
X30MSF20-12		30 x 2	20S	3/4		
X36MSF25-12		36 x 2	25S	3/4		
X36MSF25-16		36 x 2	25S	1		
X42MSF30-16		42 x 2	30S	1		
X52MSF38-20		52 x 2	38S	1 1/4		

SUPERCAT 9000 SERIES FLANGES, METRIC FITTINGS

SFH9000					ONE PIECE FLANGE - 9000 SERIES - STRAIGHT
Part No.	Price	Flange	FL. O.D.	Hose	Visual
S12SFH-9-12		3/4"	41.30 mm	3/4"	
S16SFH-9-12		1"	47.60 mm	3/4"	
S16SFH-9-16		1"	47.60 mm	1"	
S20SFH-9-16		1 1/4"	54.00 mm	1"	
S20SFH-9-20		1 1/4"	54.00 mm	1 1/4"	
S24SFH-9-20		1 1/2"	63.50 mm	1 1/4"	
S24SFH-9-24		1 1/2"	63.50 mm	1 1/2"	

*Flange Thickness - 14.3mm

SFH9000-90					ONE PIECE FLANGE - 9000 SERIES - 90°
Part No.	Price	Flange	FL. O.D.	Hose	Visual
S12SFH90S-9-12		3/4"	41.30 mm	3/4"	
S16SFH90S-9-12		1"	47.60 mm	3/4"	
S16SFH90S-9-16		1"	47.60 mm	1"	
S20SFH90S-9-16		1 1/4"	54.00 mm	1"	
S20SFH90S-9-20		1 1/4"	54.00 mm	1 1/4"	
S24SFH90S-9-20		1 1/2"	63.50 mm	1 1/4"	
S24SFH90S-9-24		1 1/2"	63.50 mm	1 1/2"	

*Flange Thickness - 14.3mm

SFH9000-45					ONE PIECE FLANGE - 9000 SERIES - 45°
Part No.	Price	Flange	FL. O.D.	Hose	Visual
S12SFH45S-9-12		3/4"	41.30 mm	3/4"	
S16SFH45S-9-12		1"	47.60 mm	3/4"	
S16SFH45S-9-16		1"	47.60 mm	1"	
S20SFH45S-9-16		1 1/4"	54.00 mm	1"	
S20SFH45S-9-20		1 1/4"	54.00 mm	1 1/4"	
S24SFH45S-9-20		1 1/2"	63.50 mm	1 1/4"	
S24SFH45S-9-24		1 1/2"	63.50 mm	1 1/2"	

*Flange Thickness - 14.3mm

X_ME (L)					METRIC SWAGE FITTINGS - LIGHT SERIES - STRAIGHT MALE
Part No.	Price	Thread	Pipe MM	Hose	Visual
X12ME06-04		12 x 1.5	6L	1/4	
X14ME06-04		14 x 1.5	6L	1/4	
X14ME08-04		14 x 1.5	8L	1/4	
X16ME10-04		16 x 1.5	10L	1/4	
X16ME10-05		16 x 1.5	10L	5/16	
X16ME10-06		16 x 1.5	10L	3/8	
X18ME12-05		18 x 1.5	12L	5/16	
X18ME12-06		18 x 1.5	12L	3/8	
X22ME15-06		22 x 1.5	15L	3/8	
X22ME15-08		22 x 1.5	15L	1/2	
X26ME18-08		26 x 1.5	18L	1/2	
X26ME18-10		26 x 1.5	18L	5/8	
X30ME22-12		30 x 2	22L	3/4	
X36ME28-16		36 x 2	28L	1	
X45ME35-20		45 x 2	35L	1 1/4	
X52ME42-24		52 x 2	42L	1 1/2	

HOSE FITTINGS - SOLID ONE PIECE FLANGES - 6000 SERIES

SFH6000

ONE PIECE FLANGE - 6000 SERIES - STRAIGHT

Part No.	Price	Flange	FL. O.D.	Hose	Visual
S12SFH-6-08		3/4"	41.30 mm	1/2"	
S12SFH-6-12		3/4"	41.30 mm	3/4"	
S12SFH-6-16		3/4"	41.30 mm	1"	
S16SFH-6-12		1"	47.60 mm	3/4"	
S16SFH-6-16		1"	47.60 mm	1"	
S16SFH-6-20		1"	47.60 mm	1 1/4"	
S20SFH-6-16		1 1/4"	54.00 mm	1"	
S20SFH-6-20		1 1/4"	54.00 mm	1 1/4"	
S24SFH-6-20		1 1/2"	63.50 mm	1 1/4"	
S24SFH-6-24		1 1/2"	63.50 mm	1 1/2"	
S32SFH-6-24		2"	79.40 mm	1 1/2"	
S32SFH-6-32		2"	79.40 mm	2"	

SFH6000-90

ONE PIECE FLANGE - 6000 SERIES - 90°

Part No.	Price	Flange	FL. O.D.	Hose	Visual
S12SFH90S-6-08		3/4"	41.30 mm	1/2"	
S12SFH90S-6-12		3/4"	41.30 mm	3/4"	
S12SFH90S-6-16		3/4"	41.30 mm	1"	
S16SFH90S-6-12		1"	47.60 mm	3/4"	
S16SFH90S-6-16		1"	47.60 mm	1"	
S16SFH90S-6-20		1"	47.60 mm	1 1/4"	
S20SFH90S-6-16		1 1/4"	54.00 mm	1"	
S20SFH90S-6-20		1 1/4"	54.00 mm	1 1/4"	
S24SFH90S-6-20		1 1/2"	63.50 mm	1 1/4"	
S24SFH90S-6-24		1 1/2"	63.50 mm	1 1/2"	
S32SFH90S-6-24		2"	79.40 mm	1 1/2"	
S32SFH90S-6-32		2"	79.40 mm	2"	

SFH6000-45

ONE PIECE FLANGE - 6000 SERIES - 45°

Part No.	Price	Flange	FL. O.D.	Hose	Visual
S12SFH45S-6-08		3/4"	41.30 mm	1/2"	
S12SFH45S-6-12		3/4"	41.30 mm	3/4"	
S12SFH45S-6-16		3/4"	41.30 mm	1"	
S16SFH45S-6-12		1"	47.60 mm	3/4"	
S16SFH45S-6-16		1"	47.60 mm	1"	
S16SFH45S-6-20		1"	47.60 mm	1 1/4"	
S20SFH45S-6-16		1 1/4"	54.00 mm	1"	
S20SFH45S-6-20		1 1/4"	54.00 mm	1 1/4"	
S24SFH45S-6-20		1 1/2"	63.50 mm	1 1/4"	
S24SFH45S-6-24		1 1/2"	63.50 mm	1 1/2"	
S32SFH45S-6-24		2"	79.40 mm	1 1/2"	
S32SFH45S-6-32		2"	79.40 mm	2"	

HOSE FITTINGS - SOLID ONE PIECE FLANGES - 3000 SERIES

SFH3000-90

ONE PIECE FLANGE - 3000 SERIES - 90°

Part No.	Price	Flange	FL. O.D.	Hose	Visual
S08SFH90S-3-08		1/2"	30.20 mm	1/2"	
S12SFH90S-3-08		3/4"	38.10 mm	1/2"	
S12SFH90S-3-12		3/4"	38.10 mm	3/4"	
S12SFH90S-3-16		3/4"	38.10 mm	1"	
S16SFH90S-3-12		1"	44.50 mm	3/4"	
S16SFH90S-3-16		1"	44.50 mm	1"	
S16SFH90S-3-20		1"	44.50 mm	1 1/4"	
S20SFH90S-3-16		1 1/4"	50.80 mm	1"	
S20SFH90S-3-20		1 1/4"	50.80 mm	1 1/4"	
S24SFH90S-3-20		1 1/2"	60.30 mm	1 1/4"	
S24SFH90S-3-24		1 1/2"	60.30 mm	1 1/2"	
S32SFH90S-3-24		2"	71.4 mm	1 1/2"	
S32SFH90S-3-32		2"	71.4 mm	2"	

SFH3000-45

ONE PIECE FLANGE - 3000 SERIES - 45°

Part No.	Price	Flange	FL. O.D.	Hose	Visual
S08SFH45S-3-08		1/2"	30.20 mm	1/2"	
S12SFH45S-3-08		3/4"	38.10 mm	1/2"	
S12SFH45S-3-12		3/4"	38.10 mm	3/4"	
S12SFH45S-3-16		3/4"	38.10 mm	1"	
S16SFH45S-3-12		1"	44.50 mm	3/4"	
S16SFH45S-3-16		1"	44.50 mm	1"	
S16SFH45S-3-20		1"	44.50 mm	1 1/4"	
S20SFH45S-3-16		1 1/4"	50.80 mm	1"	
S20SFH45S-3-20		1 1/4"	50.80 mm	1 1/4"	
S24SFH45S-3-20		1 1/2"	60.30 mm	1 1/4"	
S24SFH45S-3-24		1 1/2"	60.30 mm	1 1/2"	
S32SFH45S-3-24		2"	71.4 mm	1 1/2"	
S32SFH45S-3-32		2"	71.4 mm	2"	

3000 SERIES

SPLIT FLANGES

6000 SERIES

Part No.	Price	Size	Visual	Part No.	Price	Size
	per pair				per pair	
SF3000-08		1/2"		SF6000-08		1/2"
SF3000-12		3/4"		SF6000-12	65.64	3/4"
SF3000-16		1"		SF6000-16	82.78	1"
SF3000-20		1 1/4"		SF6000-20	117.09	1 1/4"
SF3000-24		1 1/2"		SF6000-24	210.74	1 1/2"
SF3000-32		2"		SF6000-32	331.91	2"

STANDPIPES - 45° & ONE PIECE FLANGES - 3000 SERIES

MOSE 45

STAND PIPE - 45°

Part No.	Price	Thread	Hose	Visual
X06MOSE45S04		6mm	1/4"	
X08MOSE45S04		8mm	1/4"	
X10MOSE45S04		10mm	1/4"	
X10MOSE45S06		10mm	3/8"	
X12MOSE45S04		12mm	1/4"	
X12MOSE45S06		12mm	3/8"	
X15MOSE45S06		15mm	3/8"	
X15MOSE45S08		15mm	1/2"	
X16MOSE45S08		16mm	1/2"	
X18MOSE45S10		18mm	5/8"	
X20MOSE45S10		20mm	5/8"	
X22MOSE45S12		22mm	3/4"	
X25MOSE45S12		25mm	3/4"	
X25MOSE45S16		25mm	1"	

SFH3000

ONE PIECE FLANGE - 3000 SERIES - STRAIGHT

Part No.	Price	Flange	FL. O.D.	Hose	Visual
S08SFH-3-08		1/2"	30.20 mm	1/2"	
S08SFH-3-12		1/2"	30.20 mm	3/4"	
S12SFH-3-08		3/4"	38.10 mm	1/2"	
S12SFH-3-12		3/4"	38.10 mm	3/4"	
S12SFH-3-16		3/4"	38.10 mm	1"	
S16SFH-3-12		1"	44.50 mm	3/4"	
S16SFH-3-16		1"	44.50 mm	1"	
S16SFH-3-20		1"	44.50 mm	1 1/4"	
S20SFH-3-16		1 1/4"	50.80 mm	1"	
S20SFH-3-20		1 1/4"	50.80 mm	1 1/4"	
S20SFH-3-24		1 1/4"	50.80 mm	1 1/2"	
S24SFH-3-20		1 1/2"	60.30 mm	1 1/4"	
S24SFH-3-24		1 1/2"	60.30 mm	1 1/2"	
S32SFH-3-24		2"	71.4 mm	1 1/2"	
S32SFH-3-32		2"	71.4 mm	2"	

HOSE FITTINGS - STANDPIPES - STRAIGHT & 90°

MOSE				STAND PIPE - STRAIGHT
Part No.	Price	Thread	Hose	Visual
X06MOSE04		6mm	1/4"	
X08MOSE04		8mm	1/4"	
X08MOSE06		8mm	3/8"	
X10MOSE04		10mm	1/4"	
X10MOSE06		10mm	3/8"	
X12MOSE04		12mm	1/4"	
X12MOSE06		12mm	3/8"	
X12MOSE08		12mm	1/2"	
X14MOSE06		14mm	3/8"	
X14MOSE08		14mm	1/2"	
X15MOSE06		15mm	3/8"	
X15MOSE08		15mm	1/2"	
X16MOSE08		16mm	1/2"	
X18MOSE08		18mm	1/2"	
X18MOSE10		18mm	5/8"	
X18MOSE12		18mm	3/4"	
X20MOSE10		20mm	5/8"	
X20MOSE12		20mm	3/4"	
X22MOSE12		22mm	3/4"	
X22MOSE16		22mm	1"	
X25MOSE12		25mm	3/4"	
X25MOSE16		25mm	1"	
X28MOSE16		28mm	1"	
X30MOSE16		30mm	1"	
X30MOSE20		30mm	1 1/4"	
X42MOSE24		42mm	1 1/2"	

MOSE 90				STAND PIPE - 90°
Part No.	Price	Thread	Hose	Visual
X06MOSE90S04		6mm	1/4"	
X08MOSE90S04		8mm	1/4"	
X10MOSE90S04		10mm	1/4"	
X10MOSE90S06		10mm	3/8"	
X12MOSE90S04		12mm	1/4"	
X12MOSE90S06		12mm	3/8"	
X14MOSE90S06		14mm	3/8"	
X15MOSE90S06		15mm	3/8"	
X15MOSE90S08		15mm	1/2"	
X16MOSE90S08		16mm	1/2"	
X18MOSE90S08		18mm	1/2"	
X18MOSE90S10		18mm	5/8"	
X20MOSE90S10		20mm	5/8"	
X20MOSE90S12		20mm	3/4"	
X22MOSE90S12		22mm	3/4"	
X25MOSE90S12		25mm	3/4"	
X25MOSE90S16		25mm	1"	
X28MOSE90S16		28mm	1"	

ORFS HOSE FITTINGS - 45°, ORFS MALE

LORF 45

ORFS 45° FEMALE

Part No.	Price	Thread	Hose	Visual
X04LORF45S04		9/16" -18	1/4"	
X06LORF45S04		11/16" -16	1/4"	
X06LORF45S06		11/16" -16	3/8"	
X08LORF45S06		13/16" -16		
X08LORF45S08		13/16" -16	1/2"	
X10LORF45S10		1" -14	5/8"	
X12LORF45S12		1 3/16" -12	3/4"	
X16LORF45S16		1 7/16" -12	1"	
X20LORF45S20		1 11/16" -12	1 1/4"	
X24LORF45S24		2 11/16" -12	1 1/2"	

LORM

ORFS STRAIGHT MALE

Part No.	Price	Thread	Hose	Visual
X04LORM04		9/16" -18	1/4"	
X06LORM06		11/16" -16	3/8"	
X08LORM06		13/16" -16	3/8"	
X08LORM08		13/16" -16	1/2"	
X10LORM08		1" -14	1/2"	
X10LORM10		1" -14	5/8"	
X12LORM08		1 3/16" -12	1/2"	
X12LORM10		1 3/16" -12	5/8"	
X12LORM12		1 3/16" -12	3/4"	
X16LORM16		1 7/16" -12	1"	

ORFS HOSE FITTINGS - STRAIGHT, 90°

LORF

ORFS STRAIGHT FEMALE

Part No.	Price	Thread	Hose	Visual
X04LORF04		9/16" -18	1/4"	
X06LORF04		11/16" -16	1/4"	
X06LORF06		11/16" -16	3/8"	
X08LORF06		13/16" -16	3/8"	
X08LORF08		13/16" -16	1/2"	
X10LORF08		1" -14	1/2"	
X10LORF10		1" -14	5/8"	
X12LORF08		1 3/16" -12	1/2"	
X12LORF10		1 3/16" -12	5/8"	
X12LORF12		1 3/16" -12	3/4"	
X16LORF16		1 7/16" -12	1"	
X20LORF16		1 11/16" -12	1"	
X20LORF20		1 11/16" -12	1 1/4"	
X24LORF24		2 11/16" -12	1 1/2"	

LORF 90

ORFS 90° FEMALE

Part No.	Price	Thread	Hose	Visual
X04LORF90S04		9/16" -18	1/4"	
X06LORF90S04		11/16" -16	1/4"	
X06LORF90S06		11/16" -16	3/8"	
X08LORF90S06		13/16" -16	3/8"	
X08LORF90S08		13/16" -16	1/2"	
X10LORF90S08		1" -14	1/2"	
X10LORF90S10		1" -14	5/8"	
X12LORF90S08		1 3/16" -12	1/2"	
X12LORF90S10		1 3/16" -12	5/8"	
X12LORF90S12		1 3/16" -12	3/4"	
X16LORF90S12		1 7/16" -12	3/4"	
X16LORF90S16		1 7/16" -12	1"	
X20LORF90S20		1 11/16" -12	1 1/4"	
X24LORF90S24		2 11/16" -12	1 1/2"	

HOSE FITTINGS - KOMATSU, KARCHER, JAPANESE FEMALE & STAPLE LOCK

24011

KOMATSU FEMALE

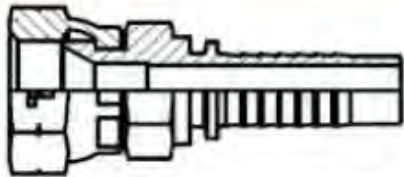
Part No.	Price	Hose	Thread	Visual
24011-04-14		1/4"	14 x 1.5	
24011-06-18		3/8"	18 x 1.5	
24011-08-22		1/2"	22 x 1.5	
24011-10-24		5/8"	24 x 1.5	
24011-12-30		3/4"	30 x 1.5	
24011-16-33		1"	33 x 1.5	

X_MSF_K

KARCHER HOSE FITTINGS

Part No.	Price	Thread	Hose	Visual
X22MSF15-04K		22 x 1.5	1/4"	
X22MSF15-05K		22 x 1.5	5/16"	
X22MSF15-06K		22 x 1.5	3/8"	

X_BJF

JAPANESE FEMALE

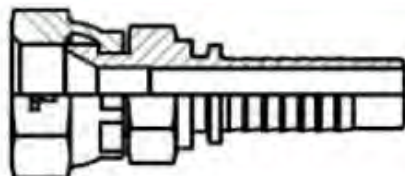
Part No.	Price	Thread	Hose	Visual
X04BJF04		1/4"	1/4"	
X06BJF06		3/8"	3/8"	
X08BJF08		1/2"	1/2"	
X12BJF12		3/4"	3/4"	
X16BJF16		1"	1"	
X20BJF20		1 1/4"	1 1/4"	

NW

STAPLE LOCK MALE FITTINGS

Part No.	Price	Size	Dash	Hose	Visual
NW06-04		1/4"	-4	1/4"	
NW10-04		1/4"	-4	1/4"	
NW10-06		3/8"	6	3/8"	
NW13-08		1/2"	8	1/2"	
NW20-12		3/4"	12	3/4"	
NW25-16		1"	16	1"	
NW32-20		1 1/4"	20	1 1/4"	

HOSE FITTINGS - NPT, BLANK TAILS, HOSE JOINERS & STAPLE LOCK

NM		NPT MALE - STRAIGHT			
X02NM03		1/8"	-2	3/16"	
X02NM04		1/8"	-2	1/4"	
X04NM04		1/4"	-4	1/4"	
X04NM06		1/4"	-4	3/8"	
X06NM04		3/8"	-6	1/4"	
X06NM06		3/8"	-6	3/8"	
X06NMS06		3/8"	-6	3/8"	
X06NM08		3/8"	-6	1/2"	
X08NM06		1/2"	-8	3/8"	
X08NM08		1/2"	-8	1/2"	
X08NM10		1/2"	-8	5/8"	
X08NM12		1/2"	-8	3/4"	
X12NM08		3/4"	-12	1/2"	
X12NM10		3/4"	-12	5/8"	
X12NM12		3/4"	-12	3/4"	
X12NM16		3/4"	-12	1"	
X16NM12		1"	-16	3/4"	
X16NM16		1"	-16	1"	
X20NM20		1 1/4"	-20	1 1/4"	
X24NM24		1 1/2"	-24	1 1/2"	
X32NM32		2"	-32	2"	

MALE SWIVEL

X_B/T		BLANK TAILS			Visual
Part No.	Price	Size	Dash	Hose	
X04B/T		1/4"	-4	1/4"	
X05B/T		5/16"	-5	5/16"	
X06B/T		3/8"	-6	3/8"	
X08B/T		1/2"	-8	1/2"	
X10B/T		5/8"	-10	5/8"	
X12B/T		3/4"	-12	3/4"	
X16B/T		1"	-16	1"	
X20B/T		1 1/4"	-20	1 1/4"	
X24B/T		1 1/2"	-24	1 1/2"	
X32B/T		2"	-32	2"	

X_H/J		HOSE JOINERS			Visual
Part No.	Price	Size	Dash	Hose	
X04H/J		1/4"	-4	1/4"	
X05H/J		5/16"	-5	5/16"	
X06H/J		3/8"	-6	3/8"	
X08H/J		1/2"	-8	1/2"	
X10H/J		5/8"	-10	5/8"	
X12H/J		3/4"	-12	3/4"	
X16H/J		1"	-16	1"	
X20H/J		1 1/4"	-20	1 1/4"	
X24H/J		1 1/2"	-24	1 1/2"	

JIC HOSE FITTINGS - 45° FEMALE & STRAIGHT MALE

X_J45

JIC HOSE END - 45° FEMALE

Part No.	Price	JIC	Dash	Hose	Visual
X07J45S04		7/16"	- 4	1/4"	
X08J45S04		1/2"	- 5	1/4"	
X09J45S04		9/16"	- 6	1/4"	
X09J45S06		9/16"	- 6	3/8"	
X10J45S06		5/8" SAE	- 7	3/8"	
X12J45S06		3/4"	- 8	3/8"	
X12J45S08		3/4"	- 8	1/2"	
X14J45S08		7/8"	- 10	1/2"	
X14J45S10		7/8"	- 10	5/8"	
X17J45S08		1 1/16"	- 12	1/2"	
X17J45S10		1 1/16"	- 12	5/8"	
X17J45S12		1 1/16"	- 12	3/4"	
X19J45S12		1 3/16"	- 14	3/4"	
X21J45S12		1 5/16"	- 16	3/4"	
X21J45S16		1 5/16"	- 16	1"	
X26J45S20		1 5/8"	- 20	1 1/4"	
X30J45S24		1 7/8"	- 24	1 1/2"	
X40J45S32		2 1/2"	- 32	2"	

X_JM

JIC HOSE END - STRAIGHT MALE

Part No.	Price	JIC	Dash	Hose	Visual
X07JM04		7/16"	- 4	1/4"	
X08JM04		1/2"	- 5	1/4"	
X09JM04		9/16"	- 6	1/4"	
X09JM05		9/16"	- 6	5/16"	
X09JM06		9/16"	- 6	3/8"	
X10JM06		5/8" SAE	- 7	3/8"	
X12JM06		3/4"	- 8	3/8"	
X12JM08		3/4"	- 8	1/2"	
X14JM08		7/8"	- 10	1/2"	
X14JM10		7/8"	- 10	5/8"	
X17JM08		1 1/16"	- 12	1/2"	
X17JM10		1 1/16"	- 12	5/8"	
X17JM12		1 1/16"	- 12	3/4"	
X19JM12		1 3/16"	- 14	3/4"	
X21JM12		1 5/16"	- 16	3/4"	
X21JM16		1 5/16"	- 16	1"	
X26JM20		1 5/8"	- 20	1 1/4"	
X30JM24		1 7/8"	- 24	1 1/2"	
X40JM32		2 1/2"	- 32	2"	

JIC HOSE FITTINGS - STRAIGHT & 90° FEMALE

X_JF

JIC HOSE END - STRAIGHT FEMALE

Part No.	Price	JIC	Dash	Hose	Visual
X07JF04		7/16"	- 4	1/4"	
X08JF04		1/2"	- 5	1/4"	
X09JF04		9/16"	- 6	1/4"	
X09JF05		9/16"	- 6	5/16"	
X09JF06		9/16"	- 6	3/8"	
X10JF04		5/8" SAE	- 7	1/4"	
X10JF06		5/8" SAE	- 7	3/8"	
X12JF06		3/4"	- 8	3/8"	
X12JF08		3/4"	- 8	1/2"	
X14JF08		7/8"	- 10	1/2"	
X14JF10		7/8"	- 10	5/8"	
X14JF12		7/8"	- 10	3/4"	
X17JF08		1 1/16"	- 12	1/2"	
X17JF10		1 1/16"	- 12	5/8"	
X17JF12		1 1/16"	- 12	3/4"	
X17JF16		1 1/16"	- 12	1"	
X19JF12		1 3/16"	- 14	3/4"	
X21JF12		1 5/16"	- 16	3/4"	
X21JF16		1 5/16"	- 16	1"	
X26JF16		1 5/8"	- 20	1"	
X26JF20		1 5/8"	- 20	1 1/4"	
X30JF24		1 7/8"	- 24	1 1/2"	
X40JF32		2 1/2"	- 32	2"	

X_J90

JIC HOSE END - 90° FEMALE

Part No.	Price	JIC	Dash	Hose	Visual
X07J90S04		7/16"	- 4	1/4"	
X08J90S04		1/2"	- 5	1/4"	
X09J90S04		9/16"	- 6	1/4"	
X09J90S06		9/16"	- 6	3/8"	
X10J90S06		5/8" SAE	- 7	3/8"	
X12J90S06		3/4"	- 8	3/8"	
X12J90S08		3/4"	- 8	1/2"	
X14J90S08		7/8"	- 10	1/2"	
X14J90S10		7/8"	- 10	5/8"	
X17J90S08		1 1/16"	- 12	1/2"	
X17J90S10		1 1/16"	- 12	5/8"	
X17J90S12		1 1/16"	- 12	3/4"	
X19J90S12		1 3/16"	- 14	3/4"	
X21J90S12		1 5/16"	- 16	3/4"	
X21J90S16		1 5/16"	- 16	1"	
X26J90S16		1 5/8"	- 20	1"	
X26J90S20		1 5/8"	- 20	1 1/4"	
X30J90S24		1 7/8"	- 24	1 1/2"	
X40J90S32		2 1/2"	- 32	2"	

BSP HOSE FITTINGS - 45°, MALE, FLAT FACE & COMPACT

X_B45		BSP HOSE END - 45° FEMALE			
Part No.	Price	BSP	Dash	Hose	Visual
X04B45S04		1/4"	-4	1/4"	
X06B45S06		3/8"	-6	3/8"	
X08B45S08		1/2"	-8	1/2"	
X10B45S08		5/8"	-10	1/2"	
X10B45S10		5/8"	-10	5/8"	
X12B45S10		3/4"	-12	5/8"	
X12B45S12		3/4"	-12	3/4"	
X16B45S16		1"	-16	1"	
X20B45S20		1 1/4"	-20	1 1/4"	
X24B45S24		1 1/2"	-24	1 1/2"	
X32B45S32		2"	-32	2"	

X_BM		BSP MALE HOSE END - STRAIGHT			
Part No.	Price	BSP	Dash	Hose	Visual
X02BM04		1/8"	-2	1/4"	
X02BMT04		1/8"	-2	1/4"	
X04BM04		1/4"	-4	1/4"	
X04BM06		1/4"	-4	3/8"	
X04BMT06		1/4"	-4	3/8"	
X06BM04		3/8"	-6	1/4"	
X06BM06		3/8"	-6	3/8"	
X08BM06		1/2"	-8	3/8"	
X08BM08		1/2"	-8	1/2"	
X10BM08		5/8"	-10	1/2"	
X10BM10		5/8"	-10	5/8"	
X12BM12		3/4"	-12	3/4"	
X16BM12		1"	-12	3/4"	
X16BM16		1"	-16	1"	
X20BM20		1 1/4"	-20	1 1/4"	
X24BM24		1 1/2"	-24	1 1/2"	
X32BM32		2"	-32	2"	

X_FF		BSP HOSE END - FLAT FACED FEMALE			
Part No.	Price	BSP	Dash	Hose	Visual
X06FF06		3/8"	-6	3/8"	
X08FF06		1/2"	-8	3/8"	
X08FF08		1/2"	-8	1/2"	
X12FF08		3/4"	-12	1/2"	
X12FF10		3/4"	-12	5/8"	
X12FF12		3/4"	-12	3/4"	
X16FF12		1"	-16	3/4"	
X16FF16		1"	-16	1"	

X_B90_K		BSP HOSE END - COMPACT ELBOW			
Part No.	Price	BSP	Dash	Hose	Visual
X06B9006K		3/8"	-6	3/8"	
X08B9008K		1/2"	-8	1/2"	

BSP HOSE FITTINGS - STRAIGHT & 90°

X_BF

BSP HOSE END - STRAIGHT FEMALE

Part No.	Price	Size			Visual
		BSP	Dash	Hose	
X02BF04		1/8"	-2	1/4"	
X04BF04		1/4"	-4	1/4"	
X04BF06		1/4"	-4	3/8"	
X06BF04		3/8"	-6	1/4"	
X06BF05		3/8"	-6	5/16"	
X06BF06		3/8"	-6	3/8"	
X06BF08		3/8"	-6	1/2"	
X08BF06		1/2"	-8	3/8"	
X08BF08		1/2"	-8	1/2"	
X08BF10		1/2"	-8	5/8"	
X08BF12		1/2"	-8	3/4"	
X10BF08		5/8"	-10	1/2"	
X10BF10		5/8"	-10	5/8"	
X12BF08		3/4"	-12	1/2"	
X12BF10		3/4"	-12	5/8"	
X12BF12		3/4"	-12	3/4"	
X12BF16		3/4"	-12	1"	
X16BF12		1"	-16	3/4"	
X16BF16		1"	-16	1"	
X20BF20		1 1/4"	-20	1 1/4"	
X24BF24		1 1/2"	-24	1 1/2"	
X32BF32		2"	-32	2"	



X_B90

BSP HOSE END - 90° FEMALE

Part No.	Price	Size			Visual
		BSP	Dash	Hose	
X02B90S04		1/8"	-2	1/4"	
X04B90S04		1/4"	-4	1/4"	
X06B90S04		3/8"	-6	1/4"	
X06B90S06		3/8"	-6	3/8"	
X08B90S06		1/2"	-8	3/8"	
X08B90S08		1/2"	-8	1/2"	
X10B90S08		5/8"	-10	1/2"	
X10B90S10		5/8"	-10	5/8"	
X12B90S08		3/4"	-8	1/2"	
X12B90S12		3/4"	-12	3/4"	
X16B90S16		1"	-16	1"	
X20B90S20		1 1/4"	-20	1 1/4"	
X24B90S24		1 1/2"	-24	1 1/2"	
X32B90S32		2"	-32	2"	



CRIMP/SWAGE SLEEVES

H_FLW 4 SPIRAL - SKIVE SLEEVES USE ON R12 & 4SP HOSE

Part No.	Price	Size		Skive Length mm	Crimp Dimensions		Visual
		mm	inch		R12 (mm)	4SP (mm)	
H04FLW		6	1/4	18.0		19.0	
H06FLW		10	3/8	22.0	22.7	23.0	
H08FLW		12	1/2	24.0	26.4	26.7	
H10FLW		16	5/8	27.0	30.6	30.7	
H12FLW		19	3/4	30.0	33.2	34.4	
H16FLW		25	1	38.0	41.4	42.0	
H20FLW		31	1 1/4	45.0	49.9	51.0	
H24FLW		38	1 1/2	50.0	58.8	60.0	
H32FLW		51	2	55.0	71.1	74.6	

**Please Note: The Crimp and Skive Dimensions above are for the new design sleeve.*

Please contact our sales department for information on the old design sleeve.

IL_FLW 4 SPIRAL INTERLOCK - SKIVE SLEEVES USE ON 4SH HOSE

Part No.	Price	Size		Internal Skive mm	External Skive mm	Crimp Dim mm	Visual
		mm	inch				
IL12FLW		19	3/4	15.0	48.0	34.1	
IL16FLW		25	1	17.0	61.0	41.5	
IL20FLW		31	1 1/4	22.0	70.0	50.5	
IL24FLW		38	1 1/2	22.5	79.0	58.0	
IL32FLW		51	2	30.0	83.0	74.2	

IL6_FLW 6 SPIRAL INTERLOCK - SKIVE SLEEVES USE ON R13 HOSE

Part No.	Price	Size		Internal Skive mm	External Skive mm	Crimp Dim mm	Visual
		mm	inch				
IL12FLW		19	3/4	15.0	48.0	34.0	
IL16FLW		25	1	17.0	61.0	41.5	
IL6-20FLW		31	1 1/4	22.0	70.0	53.8	
IL6-24FLW		38	1 1/2	22.5	79.0	60.5	
IL6-32FLW		51	2	30.0	83.0	77.9	

3381 TEFLON / THERMOPLASTIC SLEEVES USE ON R7, R8, TEFLON

Part No.	Price	Size		Crimp Dim R7 (mm)	Crimp Dim Teflon (mm)	Visual
		mm	inch			
3381-03		5	3/16	11.4		
3381-04		6	1/4	13.7	12.5	
3381-05		8	5/16	15.6		
3381-06		10	3/8	18.4	16.0	
3381-08		12	1/2	22.5	19.0	
3381-10		16	5/8	25.8	22.3	
3381-12		19	3/4	28.0	25.0	
3381-16		25	1	36.7	33.0	

CRIMP/SWAGE SLEEVES

CTCL1

1 WIRE - NON SKIVE SLEEVES

USE ON 1 WIRE HOSE

Part No.	Price	Size		Crimp Dim	Visual
		mm	inch	mm	
CTCL1-04		6	1/4	16.1	
CTCL1-05		8	5/16	17.9	
CTCL1-06		10	3/8	20.2	
CTCL1-08		12	1/2	23.7	
CTCL1-10		16	5/8	27.3	
CTCL1-12		19	3/4	31.3	
CTCL1-16		25	1	39.6	
CTCL1-20		31	1 1/4	47.9	
CTCL1-24		38	1 1/2	54.7	
CTCL1-32		51	2	68.3	

**Please Note: The Crimp and Skive Dimensions above are for the new design sleeve.*

Please contact our sales department for information on the old design sleeve.

XTCL

2 WIRE - NON SKIVE SLEEVES

USE ON 2 WIRE HOSE

Part No.	Price	Size		Crimp Dim	Visual
		mm	inch	mm	
XTCL-04		6	1/4	18.1	
XTCL-05		8	5/16	19.9	
XTCL-06		10	3/8	21.7	
XTCL-08		12	1/2	25.4	
XTCL-10		16	5/8	29.3	
XTCL-12		19	3/4	33.3	
XTCL-16		25	1	42.0	
XTCL-20		31	1 1/4	53.5	
XTCL-24		38	1 1/2	59.8	
XTCL-32		51	2	72.3	

**Please Note: The Crimp and Skive Dimensions above are for the new design sleeve.*

Please contact our sales department for information on the old design sleeve.

CX_BD

2 WIRE - SKIVE SLEEVES

USE ON 2 WIRE HOSE

Part No.	Price	Size		Skive Length	Crimp Dim	Visual
		mm	inch	mm	mm	
CX04BD		6	1/4	20.0	16.4	
CX05BD		8	5/16	20.0	17.9	
CX06BD		10	3/8	23.0	20.0	
CX08BD		12	1/2	27.0	23.7	
CX10BD		16	5/8	27.0	28.2	
CX12BD		19	3/4	31.0	32.3	
CX16BD		25	1	34.0	40.0	
CX20BD		31	1 1/4	39.0	49.6	
CX24BD		38	1 1/2	43.0	57.6	
CX32BD		51	2	58.0	70.5	

**Please Note: The Crimp and Skive Dimensions above are for the new design sleeve.*

Please contact our sales department for information on the old design sleeve.

Hose Fittings Index -3

InterLock Hose Fittings

InterLock 3000 Series Solid Flange - Straight	IL_SFH_3	Page 18
InterLock 3000 Series Solid Flange - 90°	IL_SFH90-3	Page 18
InterLock 3000 Series Solid Flange - 45°	IL_SFH45-3	Page 18
InterLock 6000 Series Solid Flange - Straight	IL_SFH_6	Page 19
InterLock 6000 Series Solid Flange - 90°	IL_SFH90-6	Page 19
InterLock 6000 Series Solid Flange - 45°	IL_SFH45-6	Page 19
InterLock Hose End - JIC Female Straight	IL_JF	Page 19
InterLock Hose End - JIC Female 90°	IL_J90S	Page 20
InterLock Hose End - JIC Female 45°	IL_J45S	Page 20
InterLock Hose End - BSP Female - Straight	IL_BF	Page 20
InterLock Hose End - BSP Female - 90°	IL_B90	Page 20
InterLock Hose End - NPT Male - Straight	IL_NM	Page 20
InterLock Hose End - ORFS Female - Straight	IL_LORF	Page 21
InterLock Hose End - ORFS Female - 90°	IL_LORF90	Page 21
InterLock Hose End - Metric Straight	IL_MSJ	Page 21
InterLock Hose End - Metric 90°	IL_MSJ90	Page 21
InterLock Hose End - Metric 45°	IL_MSJ45	Page 21

Re-Usable Hose Fittings

Re-Usable Sleeve	R2T	Page 22
Re-Usable - BSP Female Straight	R_BF	Page 22
Re-Usable - BSP Female 90°	R_B90	Page 22
Re-Usable - NPT Male	R_NM	Page 22
Re-Usable - JIC Female Straight	R_JF	Page 22
Re-Usable - JIC Female 90°	R_J90	Page 23
Re-Usable - JIC Male	R_JM	Page 23

Plastic Protection Plugs & Flange Plastic Caps

BSP Female Plugs - Suits BSP Male Fittings	TFG	Page 2
JIC/UNF Female Plugs - Suits JIC/UNF Male Fittings	TFU	Page 2
Flange Plastic Caps - 3000 Series - Suits Flanges	FL3000	Page 2
Flange Plastic Caps - 6000 Series - Suits Flanges	FL6000	Page 2
BSP Male Plugs - Suits BSP Female Fittings	TMG	Page 3
JIC/UNF Male Plugs - Suits JIC/UNF Female Fittings	TMU	Page 3

Hose Fittings Index -2

Stand Pipes

Stand Pipe - Straight	MOSE	Page 11
Stand Pipe - 90°	MOSE90	Page 11
Stand Pipe - 45°	MOSE45	Page 12

Solid One Piece Flanges & Split Flanges

Straight Flange - 3000 Series	SFH-3	Page 12
90° Flange - 3000 Series	SFH90S-3	Page 13
45° Flange - 3000 Series	SFH45S-3	Page 13
Straight Flange - 6000 Series	SFH-6	Page 14
90° Flange - 6000 Series	SFH90S-6	Page 14
45° Flange - 6000 Series	SFH45S-6	Page 14
Straight Flange - 9000 Series	SFH-9	Page 15
90° Flange - 9000 Series	SFH90S-9	Page 15
45° Flange - 9000 Series	SFH45S-9	Page 15
Split Flange - 3000 Series	SF3000	Page 18
Split Flange - 6000 Series	SF6000	Page 18

Metric Fittings

Metric Swage Fitting Light Series (L) - Straight Male	X_ME	Page 15
Metric Swage Fitting Heavy Series (H) - Straight Male	X_ME	Page 16
Metric Swage Fitting Light Series (L) - Straight Female	X_MSF	Page 16
Metric Swage Fitting Heavy Series (H) - Straight Female	X_MSF	Page 16
Metric Swage Fitting Light Series (L) - 90° Female	X_MSF90	Page 17
Metric Swage Fitting Heavy Series (H) - 90° Female	X_MSF90	Page 17
Metric Swage Fitting Light Series (L) - 45° Female	X_MSF45	Page 17
Metric Swage Fitting Heavy Series (H) - 45° Female	X_MSF45	Page 18

JIC Flange Adaptor - 3000 Series

Straight Flange Adaptor	15T3	Page 23
90° Flange Adaptor	19T3	Page 23
45° Flange Adaptor	17T3	Page 23

Brass PushLok Fittings

Brass Pushlok Fittings - JIC Female	30682	Page 24
Brass Pushlok Fittings - NPT Male	30182	Page 24
Brass Pushlok Fittings - BSP Female	39282	Page 24
Brass Pushlok Fittings - Hose Joiners	38282	Page 24

Hose Fittings Index -1

Sleeves

1 Wire - Non Skive Sleeve	CTCL1	Page 1
2 Wire - Non Skive Sleeve	XTCL	Page 1
2 Wire - Skive Sleeve	CX_BD	Page 1
4 Spiral - R12	H_FLW	Page 2
4 Spiral Interlock - R12/R9R/4SP	IL_FLW	Page 2
6 Spiral Interlock - R13/4SH	IL6_FLW	Page 2
Teflon/ThermoPlastic Sleeve - R7/R8/Teflon	3381	Page 2

BSP Hose Fittings

BSP Hose End - Straight Female	X_BF	Page 3
BSP Hose End - 90° Female	X_B90	Page 3
BSP Hose End - 45° Female	X_B45	Page 4
BSP Hose End - Straight Male	X_BM	Page 4
BSP Hose End - Flat Faced Female	X_FF	Page 4
BSP Hose End - Compact Elbow	X_B90_K	Page 4

JIC Hose Fittings

JIC Hose End - Straight Female	X_JF	Page 5
JIC Hose End - 90° Female	X_J90	Page 5
JIC Hose End - 45° Female	X_J45	Page 6
JIC Hose End - Straight Male	X_JM	Page 6

ORFS Hose Ends

ORFS Straight Female	LORF	Page 9
ORFS 90° Female	LORF90	Page 9
ORFS 45° Female	LORF45	Page 10
ORFS Straight Male	LORM	Page 10

Other Hose Ends

NPT Male	NM	Page 7
Blank Tails	X_B/T	Page 7
Hose Joiners	X_H/J	Page 7
Komatsu Female	24011	Page 8
Karcher Hose Fittings	X_MS_F_K	Page 8
Japanese Female	X_BJF	Page 8
Staple Lock Male Fittings	NW	Page 8
One Piece Brake Fittings	EF	Page 25



African
Hose
Solutions

Section B | **Hose Fittings**



069 962 1589



010 065 387 2 / 3 / 4



Admin@AfricanHoseSolutions.co.za



Facebook.com/AfricanHoseSolutions

SPIRAL GUARD HOSE PROTECTION



- Suitable for the protection of most types of hydraulic, pneumatic and industrial hose assemblies across a wide range of industries, Exceptional anti-crushing performance
- High abrasion resistance, Good resistance to UV rays, Easy to fit - reduces risk of industrial injury, Suitable for wrapping single hoses or multiple-hose looms, Proven in arduous conditions
- Operating temperature: minimum -65°C, continuous +90°C, max +100°C
- Anti Static

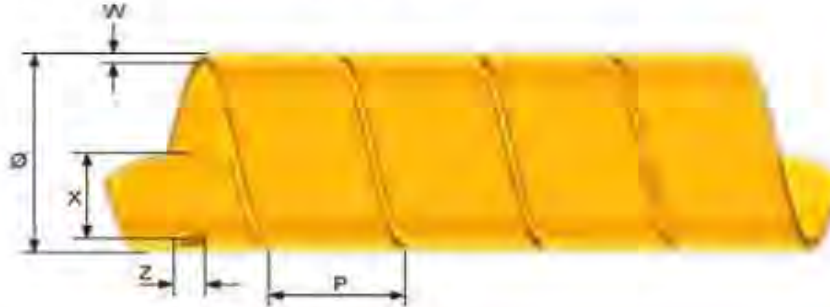

SPIRAL GUARD				Wall	Pitch	HOSE GUIDE			Hose OD Range	Pack Qty	
Part No.	Price p/m	I.D. mm	O.D. mm	(W) mm	(P) mm	1 Wire	2 Wire	Spiral	mm	mtrs	c. kg/m
SGX12		9,6	12	1,2	10,5	-03	-	-	-	25	0,04
SGX16		13,4	16	1,3	12	-04 to -06	-04 to -05	-	13 - 18	25	0,06
SGX20		16,0	20	2,0	20	-06 to -08	-06 to -08	-06	18 - 24	25	0,09
SGX25		20,6	25	2,2	25	-10 to -12	-08 to -10	-08	24 - 28	25	0,15
SGX32		27,0	32	2,5	30	-12 to -16	-12 to -16	-10 to -16	28 - 40	25	0,19
SGX40		34,6	40	2,7	24	-16	-16	-16	35 - 45	25	0,30
SGX50		43,2	50	3,4	30	-20 to -24	-20 to -24	-20	40 - 55	25	0,40
SGX63		55,6	63	3,7	37	-24	-24	-24	55 - 62	25	0,65
SGX75		66,2	75	4,4	42	-32	-32	-32	60 - 70	20	0,73
SGX90		80,2	90	4,9	45			-32	70 - 90	20	1,20
SGX110		99,0	110	5,5	50				80 - 105	15	1,76

* Calculation of Spiral Guard Needed: (O.D. of Hose/I.D. of Hose) * (length of hose)

COIL SPRING HOSE PROTECTION

COIL SPRING				Dash Size	
Part No.	Price	Hose Size		Dash Size	Coil Spring I.D.
		mm	inches		mm
CS04		6	1/4	-4	16.5
CS06		10	3/8	-6	22.0
CS08		12	1/2	-8	25.2
CS10		16	5/8	-10	29.3
CS12		19	3/4	-12	32.5
CS16		25	1	-16	40.0
CS20		31	1-1/4	-20	50.0
CS24		38	1-1/2	-24	54.2
CS32		51	2	-32	68.5





SEWER CLEANING HOSE - 120m ASSEMBLY



HOSE CONSTRUCTION

TUBE: Polyethylene

REINFORCEMENT: 1 or braids of synthetic fibre, plus one special extra braid of synthetic fibre

COVER: Polyurethane, yellow or orange

TEMPERATURE RANGE: -40°C to +60°C

SEWER CLEANING HOSE											
Part No.	Price	Hose Size		I.D.	O.D.	Working Pressure		Burst Pressure		Bend Radius	Weight
		mm	inch	mm	mm	bar	psi	bar	psi	mm	kg/m
SCHA-10		16	5/8	15.9		200	2900	520	7500		
SCHA-12		20	3/4	19.6	31.5	200	2900	520	7500	120	0.49
SCHA-16		25	1	25.9	38.7	200	2900	520	7500	155	0.71

*** Sold as a 120m assembly complete with BSP Female Fittings on both ends**

*** Other sizes, lengths and higher pressure hose available on request**



FUEL/OIL SUCTION & DELIVERY HOSE



HOSE CONSTRUCTION

TUBE: Black PVC Nitrile - Oil, Fuel & Diesel Resistant

REINFORCEMENT: Textile Reinforcement

COVER: Black Synthetic Rubber - Abrasion & Ozone Resistant

TEMPERATURE RANGE: -25°C to +60°C

FUEL/OIL SUCTION & DELIVERY											
Part No.	Price	Hose Size		I.D.	O.D.	Working Pressure		Burst Pressure		Bend Radius	Weight
		mm	inch	mm	mm	bar	psi	bar	psi	mm	kg/m
FOSD-12						10	150	30	450		
FOSD-16		25	1	25	35	10	150	30	450	125	0.726
FOSD-20		32	1-1/4	32	43	10	150	30	450	160	0.898
FOSD-24		38	1-1/2	38	50	10	150	30	450	200	1.086
FOSD-32		51	2	51	63	10	150	30	450	225	1.33
FOSD-40		63	2-1/2	63	77	10	150	30	450	320	1.923
FOSD-48		76	3	76	92	10	150	30	450	400	2.76
FOSD-64		102	4	102	118	10	150	30	450	550	3.84



AIR BRAKE HOSE - SAE J 1402



HOSE CONSTRUCTION

TUBE: Black smooth synthetic rubber

REINFORCEMENT: High strength synthetic yarn

COVER: black synthetic rubber, abrasion & weather resistant

TEMPERATURE RANGE: -35°C to +70°C

AIR BRAKE HOSE											
Part No.	Price	Hose Size		I.D.	O.D.	Working Pressure		Burst Pressure		Bend Radius	Weight
		mm	inch	mm	mm	bar	psi	bar	psi	mm	kg/m
AB-08		12	1/2	12.0	22.0	20	290	60	870		

* Other sizes available on request



FLEX-LOC - THE ULTIMATE PUSH-ON HOSE



HOSE CONSTRUCTION

TUBE: nitrile, RMA Class A

REINFORCEMENT: spiral aramid yarn

COVER: nitrile/PVC RMA Class A- Gray or Black

TEMPERATURE RANGE: -29°C to +82°C

FLEX-LOC PUSH-ON HOSE											
Part No.	Price	Hose Size		I.D.	O.D.	Working Pressure		Burst Pressure		Bend Radius	Weight
		mm	inch	mm	mm	bar	psi	bar	psi	mm	kg/m
FL801-04		6	1/4	6.35	12.7	17.24	250	68.97	1000	38.1	0.13
FL801-06		10	3/8	9.53	15.88	17.24	250	68.97	1000	57.15	0.18
FL801-08		12	1/2	12.7	19.05	17.24	250	68.97	1000	76.2	0.24
FL801-10		26	5/8	15.9	23.0	17.24	250	68.97	1000	95.25	0.33
FL801-12		19	3/4	19.1	26.2	17.24	250	68.97	1000	114.3	0.37

* Please specify colour when ordering



MULTIPURPOSE HOSE - 20 BAR (300 PSI)



HOSE CONSTRUCTION

TUBE: polyamide

REINFORCEMENT: textile reinforcement

COVER: black cover polyurethane

APPLICATION: FUEL, OIL, COMPRESSED AIR & WATER, DIVERSE INDUSTRIAL APPLICATIONS

TEMPERATURE RANGE (MEDIUM): -25°C to +60°C

MULTIPURPOSE HOSE											
Part No.	Price	Hose Size		I.D.	O.D.	Working Pressure		Burst Pressure		Bend Radius	Weight
		mm	inch	mm	mm	bar	psi	bar	psi	mm	kg/m
701-04		6	1/4	6.0	13.0	20	300	60	900	51	0.20
701-05		8	5/16	8.0	15.0	20	300	60	900	67	0.28
701-06		10	3/8	10.0	17.0	20	300	60	900	83	0.31
701-08		12	1/2	13.0	21.0	20	300	60	900	107	0.44
701-10		16	5/8	16.0	26.0	20	300	60	900	131	0.49
701-12		19	3/4	19.0	29.0	20	300	60	900	155	0.64
701-14		22	7/8	22.0	32.0	20	300	60	900	180	
701-16		25	1	25.0	35.5	20	300	60	900	203	0.88



DIN EN 855 - SAE 100 R8



HOSE CONSTRUCTION

TUBE: polyester elastomer

REINFORCEMENT: one or two braids of aramid fiber

COVER: polyurethane, black, pinpricked

TEMPERATURE RANGE (MEDIUM): -40°C to +100°C - limited to +70°C for air and water based fluids

DIN EN 855 - SAE 100 R8											
Part No.	Price	Hose Size		I.D.	O.D.	Working Pressure		Burst Pressure		Bend Radius	Weight
		mm	inch	mm	mm	bar	psi	bar	psi	mm	kg/m
R8-04		8	1/4	6.5	11.5	350	5000	1400	20000	50	0.09
R8-06		10	3/8	9.7	15.5	280	4000	1120	16000	60	0.13
R8-08		12	1/2	13.0	19.9	245	3500	980	14000	80	0.20

** Other sizes available on request*



DIN EN 855 - SAE 100 R7 & R8 NON CONDUCTIVE



HOSE CONSTRUCTION

TUBE: polyester elastomer

REINFORCEMENT: one or two braids of synthetic fiber

COVER: polyurethane, orange

TEMPERATURE RANGE (MEDIUM): -40°C to +100°C - limited to +70°C for air and water based fluids

R7/R8 NON CONDUCTIVE HOSE											
Part No.	Price	Hose Size		I.D.	O.D.	Working Pressure		Burst Pressure		Bend Radius	Weight
		mm	inch	mm	mm	bar	psi	bar	psi	mm	kg/m
R7NC-06		10	3/8	9.7	16.0	160	2300	640	9200	55	0.15
R7NC-08		12	1/2	13.0	20.3	140	2000	560	8000	75	0.22
R8NC-04		6	1/4	6.5	11.5	350	5000	140	20000	50	0.09
R8NC-06		10	3/8	9.7	15.5	280	4000	1120	16000	60	0.14

** Other sizes available on request*



PAINT SPRAY HOSE - THERMOPLASTIC



HOSE CONSTRUCTION

TUBE: polyamide

REINFORCEMENT: single steel wire braid

COVER: blue cover polyurethane

TEMPERATURE RANGE (MEDIUM): -40°C to +100°C - limited to +70°C for air and water based fluids

1 WIRE PAINT SPRAY HOSE											
Part No.	Price	Hose Size		I.D.	O.D.	Working Pressure		Burst Pressure		Bend Radius	Weight
		mm	inch	mm	mm	bar	psi	bar	psi	mm	kg/m
PSH-04		6	1/4	6.5	11.5	350	5000	1400	20000	50	0.08
PSH-06		10	3/8	9.7	15.5	280	4000	1120	16000	60	0.13
PSH-08		12	1/2	13.0	19.9	245	3500	980	14000	80	0.20

** Other sizes available on request*



WAP/KARCHER STEAM HOSE - 1 WIRE



HOSE CONSTRUCTION

TUBE: EPDM, smooth

REINFORCEMENT: steel wire, braided, zinc-coated

COVER: EPDM, blue, cloth impression

TEMPERATURE RANGE (MEDIUM): +210°C (saturated steam), +95°C (hot water)

1 WIRE STEAM HOSE											
Part No.	Price	Hose Size		I.D.	O.D.	Working Pressure		Burst Pressure		Bend Radius	Weight
		mm	inch	mm	mm	bar	psi	bar	psi	mm	kg/m
8815		8	5/16	7.9	15.0	220	3120	850	12325	115	0.24
8816		10	3/8	9.5	17.4	220	3120	720	10440	125	0.33
8806		10	3/8	9.5	17.4	220	3120	720	10440	125	0.33



WAP/KARCHER STEAM HOSE - 2 WIRE



HOSE CONSTRUCTION

TUBE: EPDM, smooth

REINFORCEMENT: steel wire, braided, zinc-coated

COVER: EPDM, blue, cloth impression

TEMPERATURE RANGE (MEDIUM): +210°C (saturated steam), +95°C (hot water)

2 WIRE STEAM HOSE											
Part No.	Price	Hose Size		I.D.	O.D.	Working Pressure		Burst Pressure		Bend Radius	Weight
		mm	inch	mm	mm	bar	psi	bar	psi	mm	kg/m
9905		8	5/16	7.9	16.6	400	5800	1400	20300	115	0.39
9915		8	5/16	7.9	16.6	400	5800	1400	20300	115	0.39
9906		10	3/8	9.5	19.0	400	5800	1320	19140	125	0.50
9916		10	3/8	9.5	19.0	400	5800	1320	19140	125	0.50



DIN EN 855 - SAE 100 R7 & R7 TWIN



HOSE CONSTRUCTION

TUBE: polyester elastomer

REINFORCEMENT: one or two braids of synthetic fiber

COVER: polyurethane, black, pinpricked

TEMPERATURE RANGE (MEDIUM): -40°C to +100°C - limited to +70°C for air and water based fluids

R7 THERMOPLASTIC HOSE											
Part No.	Price	Hose Size		I.D.	O.D.	Working Pressure		Burst Pressure		Bend Radius	Weight
		mm	inch	mm	mm	bar	psi	bar	psi	mm	kg/m
R7-04		6	1/4	6.5	12.2	210	3000	840	12000	35	0.10
R7-06		10	3/8	9.7	16.0	160	2300	640	9200	55	0.15
R7-08		12	1/2	13.0	20.3	140	2000	560	8000	75	0.22
R7-10		16	5/8	16.1	23.1	105	1500	420	6000	110	0.28
R7-12		20	3/4	19.5	27.1	90	1300	360	5200	140	0.33
R7-16		25	1	25.9	34.0	70	1000	280	4000	190	0.46
R7T-06		10	3/8	9.7	16.0	160	2300	640	9200	55	0.15





*** Other sizes available on request - Also available in Twin & Multi lines**

STAINLESS STEEL CORRUGATED METALLIC HOSE (CORRUGATED TUBE WITH SINGLE BRAIDING)



HOSE CONSTRUCTION

TUBE: convoluted stainless steel tube
REINFORCEMENT: stainless steel braid
TEMPERATURE RANGE: -270°C to +700°C

FLEXIBLE METALLIC HOSE				Min. Bend Radius 		Without Braid 		Single Braid 		Double Braid 	
Part No.	Price	Nominal Bore		Static	Flexing	Pressure (kg/cm ²)		Pressure (kg/cm ²)		Pressure (kg/cm ²)	
		mm	inch			Working	Test	Working	Test	Working	Test
SS-04		8	1/4	45.0	100.0	4	6	100	150	150	225
SS-06		10	3/8	50.0	150.0	4	6	90	135	135	203
SS-08		12	1/2	65.0	200.0	3	4.5	80	120	120	180
SS-12		20	3/4	70.0	203.0	2	3	64	96	96	144
SS-16		25	1	104.0	229.0	2	3	50	75	75	113
SS-20		32	1-1/4	117.0	267.0	1.5	2.3	40	60	60	90
SS-24		40	1-1/2	152.0	292.0	1.5	2.3	30	45	45	68
SS-32		50	2	160.0	318.0	1	1.5	28	42	42	63
SS-40		65	2-1/2	175.0	508.0	1	1.5	24	36	36	54
SS-48		75	3	231.0	610.0	1	1.5	18	27	27	41
SS-64		100	4	250.0	750.0	0.8	1.2	16	24	24	36
SS-80		125	5	318.0	900.0	0.6	0.9	12	18	18	27
SS-96		150	6	353.0	1050.0	0.6	0.9	10	15	15	22.5
SS-128		200	8	456.0	1180.0	0.5	0.75	8	12	12	18

STAINLESS STEEL HOSE - LOOSE BRAIDING



HOSE CONSTRUCTION

COVER: stainless steel braiding
TEMPERATURE RANGE (MEDIUM): -40°C to +100°C (+120°C max.)

STAINLESS STEEL LOOSE BRAIDING			
Part No.	Price	Size	
		mm	inch
SSBRI-04		8	1/4
SSBRI-06		10	3/8
SSBRI-08		12	1/2
SSBRI-12		20	3/4
SSBRI-16		25	1
SSBRI-20		32	1-1/4
SSBRI-24		40	1-1/2
SSBRI-32		50	2
SSBRI-40		65	2-1/2
SSBRI-48		75	3
SSBRI-64		100	4
SSBRI-80		125	5
SSBRI-96		150	6
SSBRI-128		200	8

We specialise in custom made Flexible Stainless Steel Hose Assemblies.

We have the highest quality hose and superior delivery times at very competitive prices.



Interlocked Metallic Hose and Expansion Bellows are available on request.



R14 P.T.F.E - TEFLON HOSE



HOSE CONSTRUCTION

TUBE: SINTERED tube of polytetrafluoroethylene (P.T.F.E)

REINFORCEMENT: single braid of stainless steel wire

COVER: abrasion, ozone and weather resistant synthetic rubber

TEMPERATURE RANGE: -54°C to +204°C (+220°C max.)

R14 P.T.F.E - TEFLON HOSE										
Part No.	Price	Hose Size		I.D.	O.D.	Working Pressure		Burst Pressure		Bend Radius
		mm	inch	mm	mm	bar	psi	bar	psi	mm
TEF-02		3	1/8	3.0	6.2	225	3260	900	13040	40
TEF-04		6	1/4	6.0	8.8	180	2610	720	10440	75
TEF-06		10	3/8	9.5	12.1	165	2390	660	9560	125
TEF-08		12	1/2	12.5	16.2	120	1740	480	6960	165
TEF-10		16	5/8	16.0	18.8	88	1270	352	5080	200
TEF-12		19	3/4	19.0	23.1	70	1010	280	4040	230
TEF-16		25	1	22.2	26.2	60	870	240	3480	230



R14 P.T.F.E - CONVULATED TEFLON HOSE



CONVULATED TEFLON HOSE										
Part No.	Price	Hose Size		I.D.	O.D.	Working Pressure		Burst Pressure		Bend Radius
		mm	inch	mm	mm	bar	psi	bar	psi	mm
TEFC-08		12	1/2	13.0	19.8	135	1960	405	7840	25
TEFC-12		19	3/4	19.0	26.6	80	1160	240	4640	65



BRAKE HOSE - SAE J1401



HOSE CONSTRUCTION - TUBE: Hydraulic Brake Fluid Basis Resistant Special Synthetic Rubber

REINFORCEMENT: High Tensile Synthetic Textile

COVER: Abrasion, Ozone, Ageing, Oil and Weather Resistant Special Synthetic Rubber

APPLICATION: Used in Automotive Hydraulic Brake Systems

TEMPERATURE RANGE (MEDIUM): -45°C to +80°C

BRAKE HOSE											
Part No.	Price	Hose Size		I.D.	O.D.	Working Pressure		Burst Pressure		Bend Radius	Weight
		mm	inch	mm	mm	bar	psi	bar	psi	mm	kg/m
435-0300		3.2	1/8	3.2	10.5	276	4002	490	7105		0.09

*A full range of Brake Fittings are available - Section B (Page 32)

SAE J 517 / 100 R5









HOSE CONSTRUCTION

TUBE: oil resistant synthetic rubber

REINFORCEMENT: synthetic textile and one high tensile steel wire braid

COVER: braided cotton, impregnated with oil and weather resistant synthetic rubber

TEMPERATURE RANGE (MEDIUM): -40°C to +100°C (+120°C max.)

SAE J 517 /100 R5										
Part No.	Price	Hose Size	I.D.	O.D.	Working Pressure		Burst Pressure		Bend Radius	Weight
		inch	mm	mm	bar	psi	bar	psi	mm	kg/m
R5-04		3/16	4.8	13.2	207	3002	828	12006	76	0.26
R5-05		1/4	6.4	14.8	207	3002	828	12006	86	0.30
R5-06		5/16	7.9	17.2	155	2250	620	9000	102	0.36
R5-08		13/32	10.3	19.5	138	2001	552	8004	117	0.41
R5-10		1/2	12.7	23.4	121	1755	484	7018	140	0.57
R5-12		5/8	15.9	27.4	103	1494	412	5974	165	0.70
R5-16		7/8	22.2	31.4	55	798	220	3190	187	0.74
R5-20		1-1/8	28.6	38.1	43	624	172	2494	229	0.98
R5-24		1-3/8	34.9	44.5	34	493	136	1972	267	1.13
R5-32		1-13/16	46.0	56.4	24	348	96	1392	337	1.35
R5-40		2-3/8	60.3	72.0	24	348	96	1392		

SAE J 517 / 100 R5 BLUE (HIGH TEMP)









HOSE CONSTRUCTION

TUBE: high temperature hydraulic oil resistant synthetic rubber

REINFORCEMENT: synthetic textile and high tensile steel wire braids

COVER: blue braided cotton, impregnated with oil and weather resistant synthetic rubber

TEMPERATURE RANGE (HIGH): -50°C to +135°C (+150°C max.)

SAE J 517 /100 R5 BLUE										
Part No.	Price	Hose Size	I.D.	O.D.	Working Pressure		Burst Pressure		Bend Radius	Weight
		inch	mm	mm	bar	psi	bar	psi	mm	kg/m
R5-08BLUE		13/32	10.3	19.1	138	2001	552	8004	115	0.44
R5-10BLUE		1/2	12.7	22.9	121	1755	484	7018	140	0.60
R5-16BLUE		7/8	22.2	30.8	55	798	220	3190	185	0.74
R5-20BLUE		1-1/8	28.6	37.6	43	624	172	2494	230	0.98
R5-24BLUE		1-3/8	34.9	44.5	34	493	136	1972	265	1.21
R5-32BLUE		1-13/16	46.0	56.4	24	348	96	1392	335	1.47

DIN EN 853 1SN











HOSE CONSTRUCTION

TUBE: oil resistant synthetic rubber

REINFORCEMENT: one high tensile steel wire braid

COVER: abrasion, ozone and weather resistant synthetic rubber, MSHA approved

TEMPERATURE RANGE (MEDIUM): -40°C to +100°C (+120°C max.)

1SN											
Part No.	Price	Hose Size		I.D.	O.D.	Working Pressure		Burst Pressure		Bend Radius	Weight
		mm	inch	mm	mm	bar	psi	bar	psi	mm	kg/m
D104		6	1/4	6.4	13.4	225	3265	900	13050	100	0.21
D105		8	5/16	7.9	15.0	215	3120	850	12325	115	0.24
D106		10	3/8	9.5	17.4	180	2610	720	10440	125	0.33
D108		12	1/2	12.7	20.6	160	2320	640	9280	180	0.41
D110		16	5/8	15.9	23.7	130	1885	520	7540	200	0.45
D112		19	3/4	19.0	27.7	105	1525	420	6090	240	0.58
D116		25	1	25.4	35.6	88	1275	350	5075	300	0.88
D120		31	1-1/4	31.8	43.5	63	915	250	3625	420	1.23
D124		38	1-1/2	38.1	50.6	50	725	200	2900	500	1.51
D132		51	2	50.8	64.0	40	580	160	2320	630	1.97

DIN EN 853 2SN











HOSE CONSTRUCTION

TUBE: oil resistant synthetic rubber

REINFORCEMENT: two high tensile steel wire braids

COVER: abrasion, ozone and weather resistant synthetic rubber, MSHA approved

TEMPERATURE RANGE (MEDIUM): -40°C to +100°C (+120°C max.)

2SN											
Part No.	Price	Hose Size		I.D.	O.D.	Working Pressure		Burst Pressure		Bend Radius	Weight
		mm	inch	mm	mm	bar	psi	bar	psi	mm	kg/m
D204		6	1/4	6.4	15.0	400	5800	1600	23200	100	0.33
D205		8	5/16	7.9	16.6	350	5075	1400	20300	115	0.39
D206		10	3/8	9.5	19.0	330	4785	1320	19140	125	0.50
D208		12	1/2	12.7	22.2	275	3990	1100	15950	180	0.59
D210		16	5/8	15.9	25.4	250	3625	1000	14500	200	0.71
D212		19	3/4	19.0	29.3	215	3120	850	12325	240	0.86
D216		25	1	25.4	38.1	165	2395	650	9425	300	1.28
D220		31	1-1/4	31.8	48.3	125	1815	500	7250	420	2.02
D224		38	1-1/2	38.1	54.6	90	1305	360	5220	500	2.20
D232		51	2	50.8	67.3	80	1160	320	4640	630	2.85

DIN EN 853 1SN - ECOLINE











HOSE CONSTRUCTION

TUBE: oil resistant synthetic rubber

REINFORCEMENT: one high tensile steel wire braid

COVER: abrasion, ozone and weather resistant synthetic rubber, MSHA approved

TEMPERATURE RANGE (MEDIUM): -40°C to +100°C (+120°C max.)

1SN - ECOLINE											
Part No.	Price	Hose Size		I.D.	O.D.	Working Pressure		Burst Pressure		Bend Radius	Weight
		mm	inch	mm	mm	bar	psi	bar	psi	mm	kg/m
1SN-04		6	1/4	6.4	13.4	225	3265	900	13050	100	0.21
1SN-05		8	5/16	7.9	15.0	215	3120	850	12325	115	0.24
1SN-06		10	3/8	9.5	17.4	180	2610	720	10440	125	0.33
1SN-08		12	1/2	12.7	20.6	160	2320	640	9280	180	0.41
1SN-10		16	5/8	15.9	23.7	130	1885	520	7540	200	0.45
1SN-12		19	3/4	19.0	27.7	105	1525	420	6090	240	0.58
1SN-16		25	1	25.4	35.6	88	1275	350	5075	300	0.88
1SN-20		31	1-1/4	31.8	43.5	63	915	250	3625	420	1.23
1SN-24		38	1-1/2	38.1	50.6	50	725	200	2900	500	1.51
1SN-32		51	2	50.8	64.0	40	580	160	2320	630	1.97

DIN EN 853 2SN - ECOLINE











HOSE CONSTRUCTION

TUBE: oil resistant synthetic rubber

REINFORCEMENT: two high tensile steel wire braids

COVER: abrasion, ozone and weather resistant synthetic rubber, MSHA approved

TEMPERATURE RANGE (MEDIUM): -40°C to +100°C (+120°C max.)

2SN - ECOLINE											
Part No.	Price	Hose Size		I.D.	O.D.	Working Pressure		Burst Pressure		Bend Radius	Weight
		mm	inch	mm	mm	bar	psi	bar	psi	mm	kg/m
2SN-04		6	1/4	6.4	15.0	400	5800	1600	23200	100	0.33
2SN-05		8	5/16	7.9	16.6	350	5075	1400	20300	115	0.39
2SN-06		10	3/8	9.5	19.0	330	4785	1320	19140	125	0.50
2SN-08		12	1/2	12.7	22.2	275	3990	1100	15950	180	0.59
2SN-10		16	5/8	15.9	25.4	250	3625	1000	14500	200	0.71
2SN-12		19	3/4	19.0	29.3	215	3120	850	12325	240	0.86
2SN-16		25	1	25.4	38.1	165	2395	650	9425	300	1.28
2SN-20		31	1-1/4	31.8	48.3	125	1815	500	7250	420	2.02
2SN-24		38	1-1/2	38.1	54.6	90	1305	360	5220	500	2.20
2SN-32		51	2	50.8	67.3	80	1160	320	4640	630	2.85



SAE 100 R15



HOSE CONSTRUCTION - TUBE: oil resistant synthetic rubber
REINFORCEMENT: four or six high tensile steel wire spiral layers
COVER: abrasion, ozone and weather resistant synthetic rubber, MSHA approved
TEMPERATURE RANGE (MEDIUM): -40°C to +100°C (+120°C max.)

SAE 100 R15											
Part No.	Price	Hose Size		I.D.	O.D.	Working Pressure		Burst Pressure		Bend Radius	Weight
		mm	inch	mm	mm	bar	psi	bar	psi	mm	kg/m
R15-12		19	3/4	19.0		420	6090	1680	24365		
R15-16		25	1	25.4	38.9	420	6090	1680	24365	330	2.10
R15-20		31	1-1/4	31.8	48.4	420	6090	1680	24365	445	3.60
R15-24		38	1-1/2	38.1	56.3	420	6090	1680	24365	530	5.10



2SN HIGH TEMPERATURE HOSE



HOSE CONSTRUCTION
TUBE: high temperature hydraulic oil resistant synthetic rubber
REINFORCEMENT: High tensile 2 Steel Wire Braids
COVER: Oil, abrasion and weather resistant synthetic rubber (Blue Cover)
TEMPERATURE RANGE (HIGH): -50°C to +135°C (+150°C max.)

2SN HIGH TEMPERATURE											
Part No.	Price	Hose Size		I.D.	O.D.	Working Pressure		Burst Pressure		Bend Radius	Weight
		inch	mm	mm	mm	bar	psi	bar	psi	mm	kg/m
R204HT		1/4"	6.4	15.0		400	5800	1600	23200	100	0.40
R206HT		3/8"	9.5	18.9		330	4785	1320	19140	130	0.57
R208HT		1/2"	12.7	22.2		275	3988	1100	15950	180	0.68
R212HT		3/4"	19.0	29.2		215	3118	850	12325	240	0.99
R216HT		1"	25.4	37.2		165	2393	650	9425	300	1.38
R220HT		1 1/4"	31.8	47.3		125	1813	500	7250	420	2.04
R224HT		1 1/2"	38.1	53.7		90	1305	360	5220	500	2.28
R232HT		2"	50.8	66.7		78	1131	310	4500	630	2.97



FIRE SUPPRESSION HOSE - 1 SN (1 WIRE)



HOSE CONSTRUCTION
TUBE: oil resistant synthetic rubber
REINFORCEMENT: High tensile 1 Steel Wire Braid
COVER: abrasion and weather resistant synthetic rubber (Red Cover)
TEMPERATURE RANGE: -40°C to +100°C (+120°C max.)

1SN FIRE SUPPRESSION HOSE											
Part No.	Price	Hose Size		I.D.	O.D.	Working Pressure		Burst Pressure		Bend Radius	Weight
		inch	mm	mm	mm	bar	psi	bar	psi	mm	kg/m
FSH-04		1/4"	6.4	13.4		225	3265	900		100	0.21
FSH-06		3/8"	9.5	17.4		180	2610	720		125	0.33
FSH-08		1/2"	12.7	20.6		160	2320	640		180	0.41
FSH-12		3/4"	19.0	27.7		105	1525	420		240	0.58



DIN EN 856 4SP - 4 SPIRAL BLACK



HOSE CONSTRUCTION - TUBE: oil resistant synthetic rubber

REINFORCEMENT: four high tensile steel wire spirals

COVER: abrasion, ozone and weather resistant synthetic rubber, MSHA approved

TEMPERATURE RANGE (MEDIUM): -40°C to +100°C (+120°C max.)

DIN EN 856 4SP											
Part No.	Price	Hose Size		I.D.	O.D.	Working Pressure		Burst Pressure		Bend Radius	Weight
		mm	inch	mm	mm	bar	psi	bar	psi	mm	kg/m
4SP-04		6	1/4	6.4	17.9	450	6500	1800	26100	150	0.63
4SP-06		10	3/8	9.5	21.4	445	6455	1780	25810	180	0.78
4SP-08		12	1/2	12.7	24.6	425	6165	1700	24650	230	0.93
4SP-10		16	5/8	15.9	28.2	350	5075	1400	20300	250	1.17
4SP-12		19	3/4	19.0	32.2	350	5075	1400	20300	300	1.48
4SP-16		25	1	25.4	39.7	280	4060	1120	16240	340	2.02
4SP-20		31	1-1/4	31.8	50.8	210	3045	840	12180	460	3.05
4SP-24		38	1-1/2	38.1	57.2	185	2685	740	10730	560	3.52
4SP-32		51	2	50.8	69.8	165	2395	660	9570	660	5.20



DIN EN 856 4SH - 4 SPIRAL BLACK



HOSE CONSTRUCTION - TUBE: oil resistant synthetic rubber

REINFORCEMENT: four high tensile steel wire spiral layers

COVER: abrasion, ozone and weather resistant synthetic rubber, MSHA approved

TEMPERATURE RANGE (MEDIUM): -40°C to +100°C (+120°C max.)

DIN EN 856 4SH											
Part No.	Price	Hose Size		I.D.	O.D.	Working Pressure		Burst Pressure		Bend Radius	Weight
		mm	inch	mm	mm	bar	psi	bar	psi	mm	kg/m
4SH-12		19	3/4	19.0	32.2	420	6090	1680	24360	280	1.53
4SH-16		25	1	25.4	38.7	380	5510	1520	22040	340	2.06
4SH-20		31	1-1/4	31.8	45.5	345	5000	1380	20010	460	2.46
4SH-24		38	1-1/2	38.1	53.5	290	4205	1160	16820	560	3.35
4SH-32		51	2	50.8	68.1	250	3625	1000	14500	700	4.55



DIN EN 856 - SAE 100 R13 - 6 SPIRAL



HOSE CONSTRUCTION - TUBE: oil resistant synthetic rubber

REINFORCEMENT: four or six high tensile steel wire spiral layers

COVER: abrasion, ozone and weather resistant synthetic rubber, MSHA approved

TEMPERATURE RANGE (MEDIUM): -40°C to +100°C (+120°C max.)

DIN EN 856 - SAE 100 R13											
Part No.	Price	Hose Size		I.D.	O.D.	Working Pressure		Burst Pressure		Bend Radius	Weight
		mm	inch	mm	mm	bar	psi	bar	psi	mm	kg/m
R13-12		19	3/4	19.0	32.0	350	5075	1400	20300	240	1.65
R13-16		25	1	25.4	39.2	350	5075	1400	20300	300	2.25
R13-20		31	1-1/4	31.8	49.8	350	5075	1400	20300	420	3.60
R13-24		38	1-1/2	38.1	57.3	350	5075	1400	20300	500	4.75
R13-32		51	2	50.8	71.9	350	5075	1400	20300	630	6.90

DIN EN 853 2ST - SAE 100 R2A









HOSE CONSTRUCTION

TUBE: oil resistant synthetic rubber

REINFORCEMENT: two high tensile steel wire braid

COVER: abrasion, ozone and weather resistant synthetic rubber, MSHA approved

TEMPERATURE RANGE (MEDIUM): -40°C to +100°C (+120°C max.)

DIN EN 853 2ST - SAE 100 R2A											
Part No.	Price	Hose Size		I.D.	O.D.	Working Pressure		Burst Pressure		Bend Radius	Weight
		mm	inch	mm	mm	bar	psi	bar	psi	mm	kg/m
R204A		6	1/4	6.4	17.5	400	5805	1600	23200	100	0.41
R206A		10	3/8	9.5	21.4	330	4790	1320	19140	130	0.60
R208A		12	1/2	12.7	24.6	275	4000	1100	16000	180	0.78
R210A		16	5/8	15.9	27.8	250	3625	1000	14500	200	0.83
R212A		19	3/4	19.0	31.8	215	3120	850	12325	240	1.02
R216A		25	1	25.4	39.7	165	2395	650	9425	300	1.38

DIN EN 856 - SAE 100 R12









HOSE CONSTRUCTION

TUBE: oil resistant synthetic rubber

REINFORCEMENT: four high tensile steel wire spiral layers

COVER: abrasion, ozone and weather resistant synthetic rubber, grey, MSHA approved

TEMPERATURE RANGE (MEDIUM): -40°C to +100°C (+120°C max.)

DIN EN 856 - SAE 100 R12											
Part No.	Price	Hose Size		I.D.	O.D.	Working Pressure		Burst Pressure		Bend Radius	Weight
		mm	inch	mm	mm	bar	psi	bar	psi	mm	kg/m
R12-06		10	3/8	9.5	20.3	280	4060	1120	16240	125	0.70
R12-08		12	1/2	12.7	23.8	280	4060	1120	16240	180	0.84
R12-10		16	5/8	15.9	27.4	280	4060	1120	16240	200	1.10
R12-12		19	3/4	19.0	30.7	280	4060	1120	16240	240	1.33
R12-16		25	1	25.4	38.0	280	4060	1120	16240	300	1.85
R12-20		31	1-1/4	31.8	47.0	210	3045	840	12180	420	2.65
R12-24		38	1-1/2	38.1	53.5	175	2540	700	10150	500	3.20
R12-32		51	2	50.8	66.7	175	2540	700	10150	630	4.50

DIN EN 853 1SN - SAE 100 R1 AT









HOSE CONSTRUCTION

TUBE: oil resistant synthetic rubber

REINFORCEMENT: one high tensile steel wire braid

COVER: abrasion, ozone and weather resistant synthetic rubber, MSHA approved

TEMPERATURE RANGE (MEDIUM): -40°C to +100°C (+120°C max.)

DIN EN 853 1SN - SAE 100 R1 AT											
Part No.	Price	Hose Size		I.D.		Working Pressure		Burst Pressure		Bend Radius	Weight
		mm	inch	mm	mm	bar	psi	bar	psi		
R104		6	1/4	6.4	13.4	225	3265	900	13050	100	0.21
R105		8	5/16	7.9	15.0	215	3120	850	12325	115	0.24
R106		10	3/8	9.5	17.4	180	2610	720	10440	125	0.33
R108		12	1/2	12.7	20.6	160	2320	640	9280	180	0.41
R110		16	5/8	15.9	23.7	130	1885	520	7540	200	0.45
R112		19	3/4	19.0	27.7	105	1525	420	6090	240	0.58
R116		25	1	25.4	35.6	88	1275	350	5075	300	0.88
R120		31	1-1/4	31.8	43.5	63	915	250	3625	420	1.23
R124		38	1-1/2	38.1	50.6	50	725	200	2900	500	1.51
R132		51	2	50.8	64.0	40	580	160	2320	630	1.97

DIN EN 853 2SN - SAE 100 R2 AT









HOSE CONSTRUCTION

TUBE: oil resistant synthetic rubber

REINFORCEMENT: two high tensile steel wire braids



COVER: abrasion, ozone and weather resistant synthetic rubber, MSHA approved

TEMPERATURE RANGE (MEDIUM): -40°C to +100°C (+120°C max.)







DIN EN 853 2SN - SAE 100 R2 AT											
Part No.	Price	Hose Size		I.D.		Working Pressure		Burst Pressure		Bend Radius	Weight
		mm	inch	mm	mm	bar	psi	bar	psi		
R204		6	1/4	6.4	15.0	400	5800	1600	23200	100	0.33
R205		8	5/16	7.9	16.6	350	5075	1400	20300	115	0.39
R206		10	3/8	9.5	19.0	330	4785	1320	19140	125	0.50
R208		12	1/2	12.7	22.2	275	3990	1100	15950	180	0.59
R210		16	5/8	15.9	25.4	250	3625	1000	14500	200	0.71
R212		19	3/4	19.0	29.3	215	3120	850	12325	240	0.86
R216		25	1	25.4	38.1	165	2395	650	9425	300	1.28
R220		31	1-1/4	31.8	48.3	125	1815	500	7250	420	2.02
R224		38	1-1/2	38.1	54.6	90	1305	360	5220	500	2.20
R232		51	2	50.8	67.3	80	1160	320	4640	630	2.85

HOSE INDEX 2

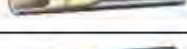

Industrial Hose

Multipurpose Hose	701	Page 12	
Fuel/Oil Suction & Delivery Hose	FOSD	Page 13	
R14 P.T.F.E - Teflon Hose	TEF	Page 8	
R14 P.T.F.E - Convuluted Teflon Hose	TEFC	Page 8	
Flex-Loc Push on Hose	FL801	Page 12	
Air Brake Hose	AB	Page 12	
Brake Hose	BH	Page 4	
WAP/KARCHER Steam Hose - 1 Wire	88	Page 10	
WAP/KARCHER Steam Hose - 2 Wire	99	Page 10	

ThermoPlastic Hose

SAE 100 R7	R7	Page 10	
SAE 100 R7 Twin	R7T	Page 10	
SAE 100 R7 - Non Conductive	R7NC	Page 11	
SAE 100 R8	R8	Page 11	
SAE 100 R8 Non Conductive	R8NC	Page 11	
Paint Spray Hose	PSH	Page 11	
Sewer Cleaning Hose	SCHA	Page 13	

Hose Protection



Spiral Guard Hose Protection	SGX	Page 14	
Coil Spring Hose Protection	CS	Page 14	

HOSE INDEX 1

Hydraulic Hose

1SN - SAE 100 R1 AT - 1 Wire Thin Cover Hose	R1	Page 1	
1SN - 1 Wire Thin Cover Hose - <i>ECOLINE</i>	1SN	Page 1	
1SN - 1 Wire Thin Cover Hose	D1	Page 6	
2SN - SAE 100 R2 AT - 2 Wire Thin Cover Hose	R2	Page 1	
2SN - 2 Wire Thin Cover Hose - <i>ECOLINE</i>	2SN	Page 1	
2SN - 2 Wire Thin Cover Hose	D2	Page 6	
2ST - SAE 100 R2 A - 2 Wire Thick Cover Hose	R2A	Page 2	
SAE 100 R12 - 4 Spiral Hose	R12	Page 2	
4SP - 4 Spiral Black Hose	4SP	Page 3	
4SH - 4 Spiral Black Hose	4SH	Page 3	
SAE 100 R13 - 4 or 6 Spiral Hose	R13	Page 3	
SAE 100 R15 - 4 or 6 Spiral Hose	R15	Page 4	
2SN - High Temperature Hose - Blue Cover	R2HT	Page 4	
1SN - Fire Suppression Hose - 1 Wire - Red Cover	FSH	Page 4	
SAE 100 R5 Black Hose	R5	Page 7	
SAE 100 R5 Blue Hose - High Temperature	R5BLUE	Page 7	

Metallic Hose

Stainless Steel Metallic Hose	SS	Page 9	
Stainless Steel Loose Braiding	SSBRI	Page 9	



African
Hose
Solutions

Section A | **Hose & Hose Protection**



069 962 1589



010 065 387 2 / 3 / 4



Admin@AfricanHoseSolutions.co.za



Facebook.com/AfricanHoseSolutions



African Hose Solutions

THIS PRICE LIST IS MADE UP OF 6 SECTIONS

- **SECTION A:** Hose & Hose Protection
- **SECTION B:** Hose Fittings
- **SECTION C:** Quick Release Couplers
- **SECTION D:** Adaptors
- **SECTION E:** Steel Tube & Steel Fittings
- **SECTION F:** Brass Fittings & Nylon Tubing

African Hose Solutions Catalogue



African
Hose
Solutions



069 962 1589



010 065 387 2 / 3 / 4



Admin@AfricanHoseSolutions.co.za